



VALUE HEATING



BROCHURE Version 1





BROCHURE Version 1

CONTENTS

CLASSICO 2 Column Horizontal _____	6
CLASSICO 3 Column Horizontal _____	8
CLASSICO 4 Column Horizontal _____	10
CLASSICO 6 Column Horizontal _____	12
CLASSICO 2 Column Vertical _____	16
CLASSICO 3 Column Vertical _____	18
HARLEY Horizontal Single _____	20
HARLEY Horizontal Double _____	24
HARLEY Vertical Single _____	28
HARLEY Vertical Double _____	32
ELIPS Horizontal Single _____	36
ELIPS Horizontal Double _____	40
ELIPS Vertical Single _____	44
ELIPS Vertical Double _____	48
ACCESSORIES Valves & Feet _____	52
TECHNICAL DRAWINGS _____	55

CLASSICO

2 / 3 / 4 / 6 Column Horizontal

white



5 YEAR GUARANTEE



QUALITY STEEL CONSTRUCTION





CLASSICO 2 Column Horizontal



CLASSICO 2 Column Horizontal

Overall Height mm	Dimension Width mm	Pipe Centres mm	Wall to Pipe Centres mm	Wall Distance mm	Number of Sections	Heat Outputs Delta T 60 C	
						BTU	Watts
500	425	425	68	92	9	1441	423
500	605	605	68	92	13	2083	611
500	830	830	68	92	18	2883	845
500	965	965	68	92	21	3999	1173
500	1190	1190	68	92	26	4165	1221
600	425	425	68	92	9	1700	499
600	605	605	68	92	13	2457	721
600	830	830	68	92	18	3401	997
600	965	965	68	92	21	4718	1384
600	1190	1190	68	92	26	4914	1441

For pipe center measurement including valves add 90mm accordingly

500mm (h) x 425mm (w)

9 Sections



500mm (h) x 605mm (w)

13 Sections



500mm (h) x 830mm (w)

18 Sections



500mm (h) x 965mm (w)

21 Sections



500mm (h) x 1190mm (w)

26 Sections



600mm (h) x 425mm (w)

9 Sections



600mm (h) x 605mm (w)

13 Sections



600mm (h) x 830mm (w)

18 Sections



600mm (h) x 965mm (w)

21 Sections



600mm (h) x 1190mm (w)

26 Sections



2 Column Feet



Scan QR code to view full digital brochure

See page 34 for compatible valves and feet

CLASSICO 3 Column Horizontal



CLASSICO 3 Column Horizontal

Overall Height mm	Dimension Width mm	Pipe Centres mm	Wall to Pipe Centres mm	Wall Distance mm	Number of Sections	Heat Outputs Delta T 60 C	
						BTU	Watts
300	830	830	68	118	18	2417	709
300	965	965	68	118	21	2818	826
300	1190	1190	68	118	26	3489	1023
300	1370	1370	68	118	30	4026	1181
400	425	425	68	118	9	1610	472
400	605	605	68	118	13	2327	682
400	830	830	68	118	18	3222	945
400	965	965	68	118	21	3758	1102
400	1190	1190	68	118	26	4653	1365
400	1370	1370	68	118	30	5367	1574
500	425	425	68	118	9	1987	583
500	605	605	68	118	13	2870	842
500	830	830	68	118	18	3973	1165
500	965	965	68	118	21	4636	1360
500	1190	1190	68	118	26	5742	1684
500	1370	1370	68	118	30	6624	1943
600	425	425	68	118	9	2346	688
600	605	605	68	118	13	3389	994
600	830	830	68	118	18	4676	1371
600	965	965	68	118	21	5455	1600
600	1190	1190	68	118	26	6755	1981
600	1370	1370	68	118	30	7793	2285
750	425	425	68	118	9	2934	860
750	605	605	68	118	13	4237	1243
750	830	830	68	118	18	5845	1714
750	965	965	68	118	21	6820	2000
750	1190	1190	68	118	26	8443	2476
750	1370	1370	68	118	30	9741	2857

For pipe center measurement including valves add 90mm accordingly

CLASSICO 3 Column Horizontal

300mm (h) x 830mm (w)
18 Sections



300mm (h) x 965mm (w)
21 Sections



300mm (h) x 1190mm (w)
26 Sections



300mm (h) x 1370mm (w)
30 Sections



400mm (h) x 425mm (w)
9 Sections



400mm (h) x 605mm (w)
13 Sections



400mm (h) x 830mm (w)
18 Sections



400mm (h) x 965mm (w)
21 Sections



400mm (h) x 1190mm (w)
26 Sections



400mm (h) x 1370mm (w)
30 Sections



500mm (h) x 425mm (w)
9 Sections



500mm (h) x 605mm (w)
13 Sections



500mm (h) x 830mm (w)
18 Sections



500mm (h) x 965mm (w)
21 Sections



500mm (h) x 1190mm (w)
26 Sections



500mm (h) x 1370mm (w)
30 Sections



600mm (h) x 425mm (w)
9 Sections



600mm (h) x 605mm (w)
13 Sections



600mm (h) x 830mm (w)
18 Sections



600mm (h) x 965mm (w)
21 Sections



600mm (h) x 1190mm (w)
26 Sections



600mm (h) x 1370mm (w)
30 Sections



750mm (h) x 425mm (w)
9 Sections



750mm (h) x 605mm (w)
13 Sections



750mm (h) x 830mm (w)
18 Sections



750mm (h) x 965mm (w)
21 Sections



750mm (h) x 1190mm (w)
26 Sections

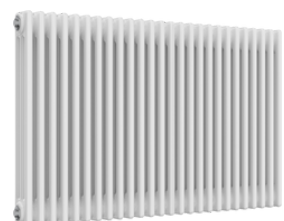

750mm (h) x 1370mm (w)
30 Sections

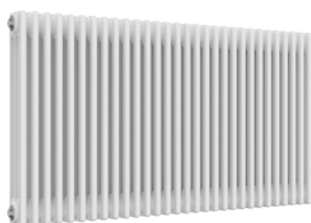

3 Column Feet



Scan QR code to view full digital brochure

See page 34 for compatible valves and feet



CLASSICO 4 Column Horizontal

CLASSICO 4 Column Horizontal

CLASSICO 4 Column Horizontal

Overall Height mm	Dimension Width mm	Pipe Centres mm	Wall to Pipe Centres mm	Wall Distance mm	Number of Sections	Heat Outputs Delta T 60 C	
						BTU	Watts
300	830	830	95	160	18	3117	914
300	965	965	95	160	21	3636	1066
300	1190	1190	95	160	26	4502	1320
300	1370	1370	95	160	30	5196	1524
400	425	425	95	160	9	2026	594
400	605	605	95	160	13	2626	858
400	830	830	95	160	18	4052	1188
400	965	965	95	160	21	4727	1386
400	1190	1190	95	160	26	5853	1716
400	1370	1370	95	160	30	6755	1981
500	425	425	95	160	9	2533	743
500	605	605	95	160	13	3658	1073
500	830	830	95	160	18	5065	1485
500	965	965	95	160	21	5910	1733
500	1190	1190	95	160	26	7316	2145
500	1370	1370	95	160	30	8443	2476
600	425	425	95	160	9	3000	880
600	605	605	95	160	13	4334	1271
600	830	830	95	160	18	6001	1760
600	965	965	95	160	21	7001	2053
600	1190	1190	95	160	26	8668	2542
600	1370	1370	95	160	30	10001	2933
750	425	425	95	160	9	3750	1100
750	605	605	95	160	13	5418	1589
750	830	830	95	160	18	7501	2200
750	965	965	95	160	21	8751	2566
750	1190	1190	95	160	26	10835	3177
750	1370	1370	95	160	30	12501	3666

For pipe center measurement including valves add 90mm accordingly

300mm (h) x 830mm (w)
18 Sections



300mm (h) x 965mm (w)
21 Sections



300mm (h) x 1190mm (w)
26 Sections



300mm (h) x 1370mm (w)
30 Sections



400mm (h) x 425mm (w)
9 Sections



400mm (h) x 605mm (w)
13 Sections



400mm (h) x 830mm (w)
18 Sections



400mm (h) x 965mm (w)
21 Sections



400mm (h) x 1190mm (w)
26 Sections



400mm (h) x 1370mm (w)
30 Sections



500mm (h) x 425mm (w)
9 Sections



500mm (h) x 605mm (w)
13 Sections



500mm (h) x 830mm (w)
18 Sections



500mm (h) x 965mm (w)
21 Sections



500mm (h) x 1190mm (w)
26 Sections



500mm (h) x 1370mm (w)
30 Sections



600mm (h) x 425mm (w)
9 Sections

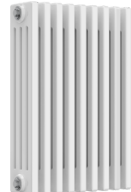

600mm (h) x 605mm (w)
13 Sections



600mm (h) x 830mm (w)
18 Sections



600mm (h) x 965mm (w)
21 Sections



600mm (h) x 1190mm (w)
26 Sections



600mm (h) x 1370mm (w)
30 Sections



750mm (h) x 425mm (w)
9 Sections



750mm (h) x 605mm (w)
13 Sections



750mm (h) x 830mm (w)
18 Sections



750mm (h) x 965mm (w)
21 Sections



750mm (h) x 1190mm (w)
26 Sections



750mm (h) x 1370mm (w)
30 Sections

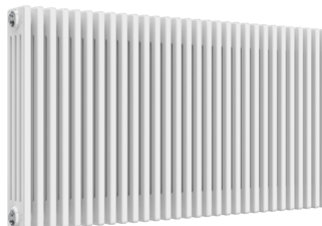

4 Column Feet



Scan QR code to view full digital brochure

See page 34 for compatible valves and feet

CLASSICO 6 Column Horizontal



CLASSICO 6 Column Horizontal

Overall Height mm	Dimension Width mm	Pipe Centres mm	Wall to Pipe Centres mm	Wall Distance mm	Number of Sections	Heat Outputs Delta T 60 C	
						BTU	Watts
300	830	830	133	243	18	4591	1346
300	965	965	133	243	21	5330	1563
300	1190	1190	133	243	26	6390	1874
400	830	830	133	243	18	6122	1795
400	965	965	133	243	21	7106	2084
400	1190	1190	133	243	26	8520	2499
500	605	605	133	243	13	5263	1543
500	830	830	133	243	18	7379	2164
500	965	965	133	243	21	8612	2526
500	1190	1190	133	243	26	10721	3144
600	605	605	133	243	13	6240	1830
600	830	830	133	243	18	8699	2551
600	965	965	133	243	21	10148	2976
600	1190	1190	133	243	26	12274	3599

For pipe center measurement including valves add 90mm accordingly

300mm (h) x 830mm (w)

18 Sections



300mm (h) x 965mm (w)

21 Sections



300mm (h) x 1190mm (w)

26 Sections



400mm (h) x 830mm (w)

18 Sections



400mm (h) x 965mm (w)

21 Sections



400mm (h) x 1190mm (w)

26 Sections



500mm (h) x 605mm (w)

13 Sections



500mm (h) x 830mm (w)

18 Sections



500mm (h) x 965mm (w)

21 Sections



500mm (h) x 1190mm (w)

26 Sections



600mm (h) x 605mm (w)

13 Sections



600mm (h) x 830mm (w)

18 Sections



600mm (h) x 965mm (w)

21 Sections

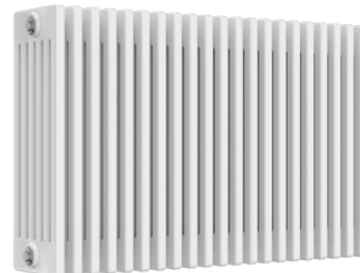

600mm (h) x 1190mm (w)

26 Sections



6 Column Feet



Scan QR code to view full digital brochure

See page 34 for compatible valves and feet

CLASSICO

2 / 3 Column Vertical

white



5 YEAR GUARANTEE



QUALITY STEEL CONSTRUCTION

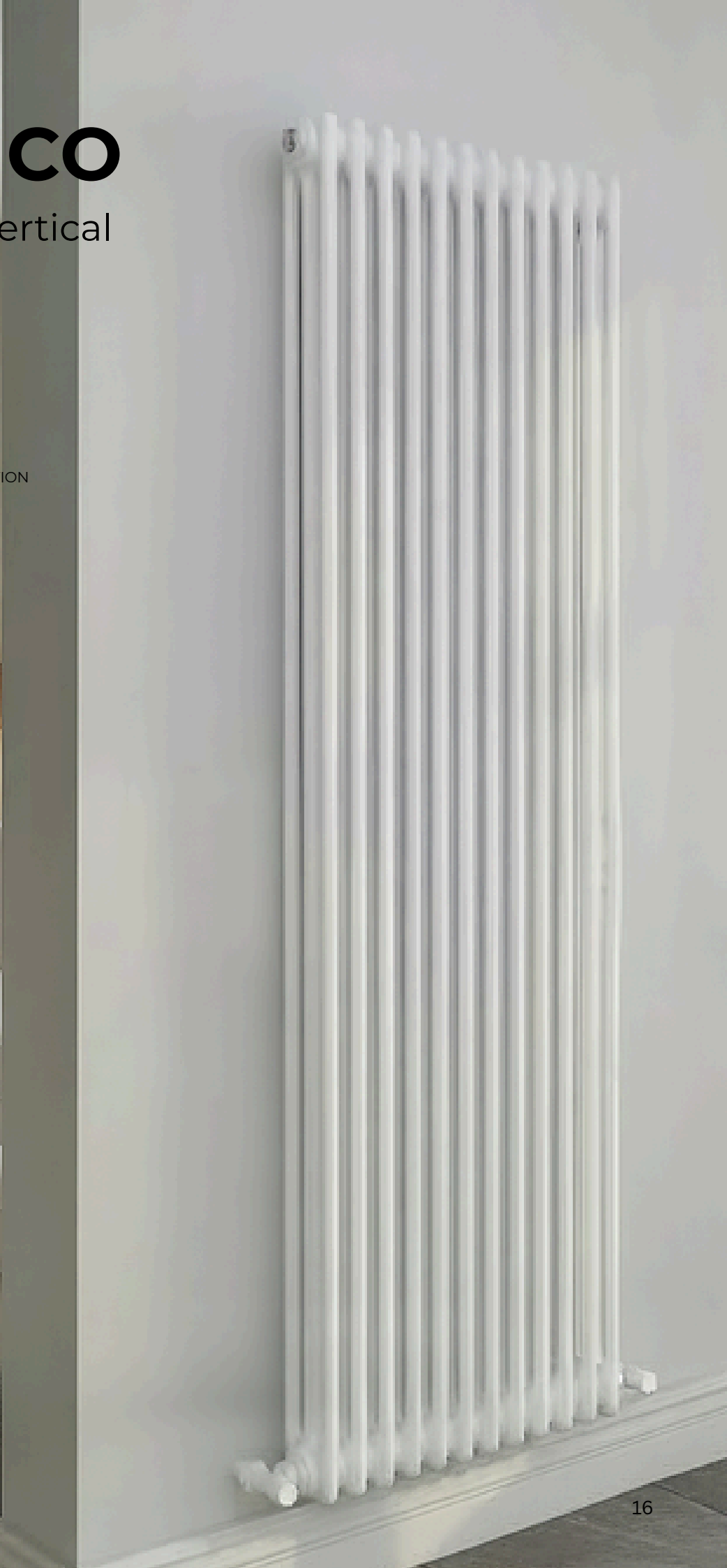



CLASSICO 2 Column Vertical



CLASSICO 2 Column Vertical

Overall Height mm	Dimension Width mm	Pipe Centres mm	Wall to Pipe Centres mm	Wall Distance mm	Number of Sections	Heat Outputs Delta T 60 C	
						BTU	Watts
1500	425	425	68	92	9	4129	1211
1500	515	515	68	92	11	5045	1479
1800	245	245	68	92	5	2705	793
1800	335	335	68	92	7	3786	1110
1800	425	425	68	92	9	4872	1429
1800	515	515	68	92	11	5955	1746
1800	560	560	68	92	12	6495	1905

For pipe center measurement including valves add 90mm accordingly

1500mm (h) x 425mm (w)

9 Sections



1500mm (h) x 515mm (w)

11 Sections



1800mm (h) x 245mm (w)

5 Sections



1800mm (h) x 335mm (w)

7 Sections



1800mm (h) x 425mm (w)

9 Sections



1800mm (h) x 515mm (w)

11 Sections

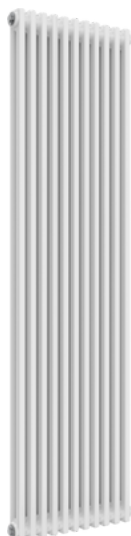

1800mm (h) x 560mm (w)

13 Sections

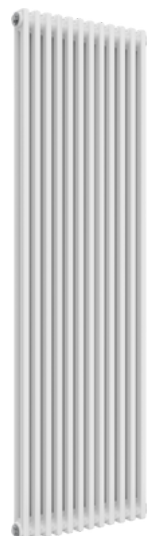

2 Column Feet



Scan QR code to view full digital brochure

See page 34 for compatible valves and feet

CLASSICO 3 Column Vertical



CLASSICO 3 Column Vertical

Overall Height mm	Dimension Width mm	Pipe Centres mm	Wall to Pipe Centres mm	Wall Distance mm	Number of Sections	Heat Outputs Delta T 60 C	
						BTU	Watts
1500	425	425	68	118	9	5572	1634
1500	515	515	68	118	11	6810	1997
1800	245	245	68	118	5	3680	1079
1800	335	335	68	118	7	5152	1511
1800	425	425	68	118	9	6625	1943
1800	515	515	68	118	11	8097	2374
1800	560	560	68	118	12	8833	2590

For pipe center measurement including valves add 90mm accordingly

1500mm (h) x 425mm (w)

9 Sections



1500mm (h) x 515mm (w)

11 Sections



1800mm (h) x 245mm (w)

5 Sections

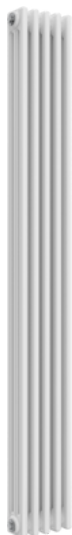

1800mm (h) x 335mm (w)

7 Sections



1800mm (h) x 425mm (w)

9 Sections



1800mm (h) x 515mm (w)

11 Sections



1800mm (h) x 560mm (w)

13 Sections

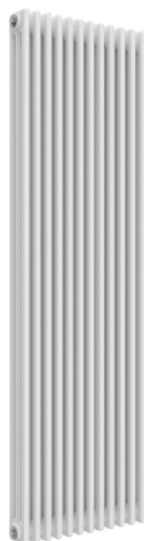

3 Column Feet



Scan QR code to view full digital brochure

See page 34 for compatible valves and feet

HARLEY

Horizontal Single

white

anthracite



5 YEAR GUARANTEE



QUALITY STEEL CONSTRUCTION

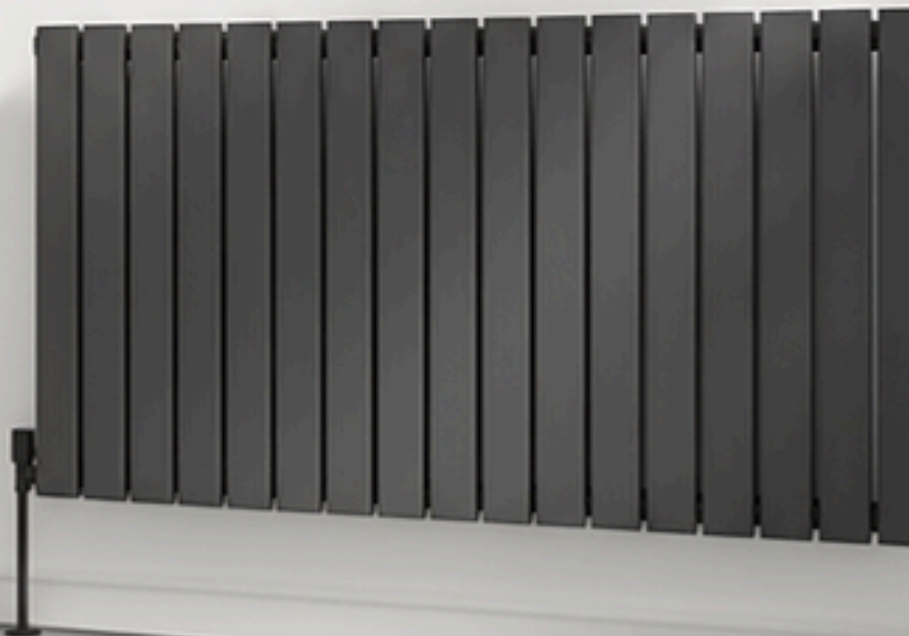

600mm (h) x 420mm (w)

6 Sections



600mm (h) x 630mm (w)

9 Sections



600mm (h) x 770mm (w)

11 Sections



600mm (h) x 980mm (w)

14 Sections



600mm (h) x 1190mm (w)

17 Sections



600mm (h) x 1470mm (w)

21 Sections



Scan QR code to view
full digital brochure

See page 34 for compatible valves

HARLEY Horizontal Single



HARLEY Horizontal Single

Overall Height mm	Dimension Width mm	Pipe Centres mm	Wall to Pipe Centres mm	Wall Distance mm	Number of Tubes	Heat Outputs Delta T 60 C	
						BTU	Watts
600	420	420	50	79	6	1220	358
600	630	630	50	79	9	1830	537
600	770	770	50	79	11	2236	656
600	980	980	50	79	14	2845	834
600	1190	1190	50	79	17	3457	1014
600	1470	1470	50	79	21	4271	1252

For pipe center measurement including valves add 90mm accordingly



HARLEY

Horizontal Double

white

anthracite



5 YEAR GUARANTEE



QUALITY STEEL CONSTRUCTION



600mm (h) x 420mm (w)

12 Panels



600mm (h) x 630mm (w)

18 Sections



600mm (h) x 770mm (w)

22 Sections



600mm (h) x 980mm (w)

28 Sections



600mm (h) x 1190mm (w)

34 Sections



600mm (h) x 1470mm (w)

42 Sections



Scan QR code to view
full digital brochure

See page 34 for compatible valves

HARLEY Horizontal Double



HARLEY Horizontal Double

Overall Height mm	Dimension Width mm	Pipe Centres mm	Wall to Pipe Centres mm	Wall Distance mm	Number of Tubes	Heat Outputs Delta T 60 C	
						BTU	Watts
600	420	420	63	94	12	1974	579
600	630	630	63	94	18	2961	868
600	770	770	63	94	22	3618	1061
600	980	980	63	94	28	4606	1351
600	1190	1190	63	94	34	5594	1640
600	1470	1470	63	94	42	6909	2026

For pipe center measurement including valves add 90mm accordingly



HARLEY

Vertical Single

white

anthracite



5 YEAR GUARANTEE



QUALITY STEEL CONSTRUCTION



1600mm (h) x 420mm (w)
6 Sections

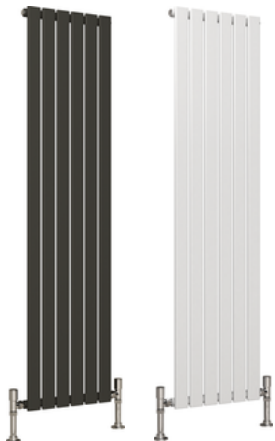

1600mm (h) x 490mm (w)
7 Sections

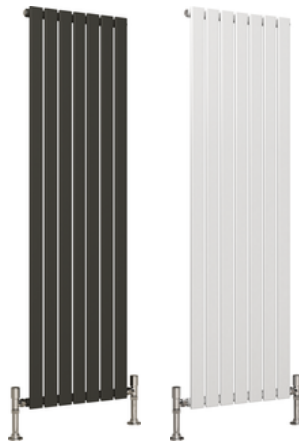

1600mm (h) x 560mm (w)
8 Sections

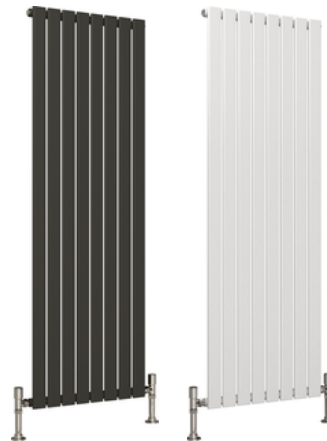

1800mm (h) x 350mm (w)
5 Sections

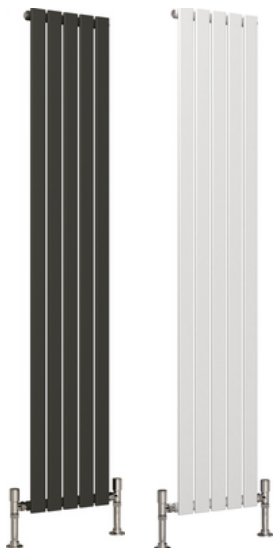

1800mm (h) x 420mm (w)
6 Sections

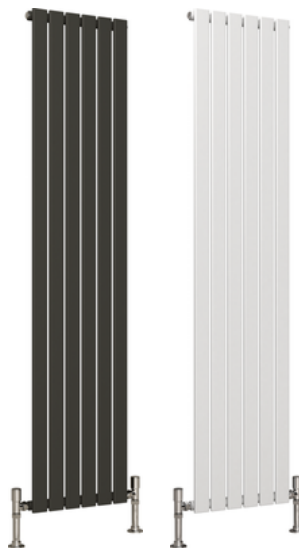

1800mm (h) x 490mm (w)
7 Sections

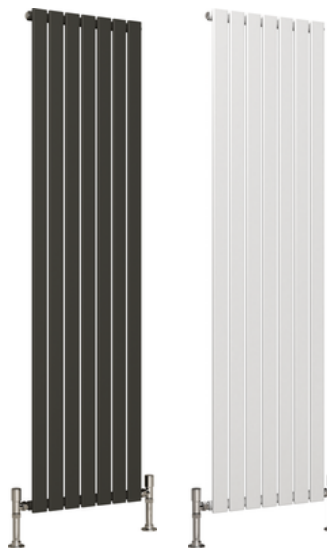

1800mm (h) x 560mm (w)
8 Sections

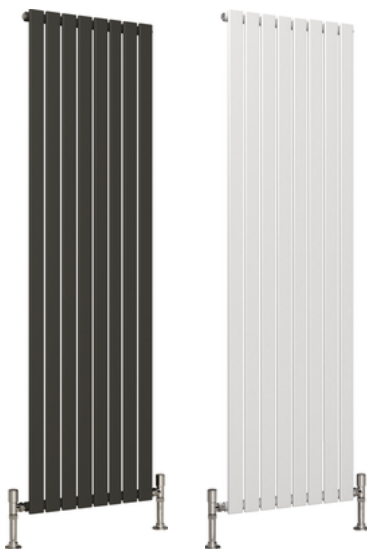

1800mm (h) x 630mm (w)
9 Sections

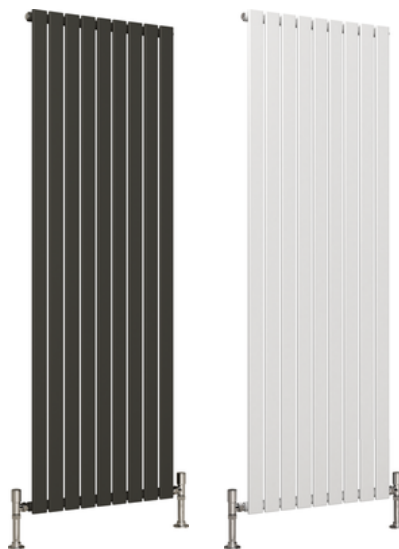

Scan QR code to view
full digital brochure

See page 34 for compatible valves

HARLEY Vertical Single



HARLEY Vertical Single

Overall Height mm	Dimension Width mm	Pipe Centres mm	Wall to Pipe Centres mm	Wall Distance mm	Number of Tubes	Heat Outputs Delta T 60 C	
						BTU	Watts
1600	420	420	50	79	6	3126	917
1600	490	490	50	79	7	3647	1070
1600	560	560	50	79	8	4168	1222
1800	350	350	50	79	5	2885	846
1800	420	420	50	79	6	3462	1015
1800	490	490	50	79	7	4038	1184
1800	560	560	50	79	8	4617	1354
1800	630	630	50	79	9	5193	1523

For pipe center measurement including valves add 90mm accordingly



HARLEY

Vertical Double

white

anthracite



5 YEAR GUARANTEE



QUALITY STEEL CONSTRUCTION



1600mm (h) x 420mm (w)
6 Sections

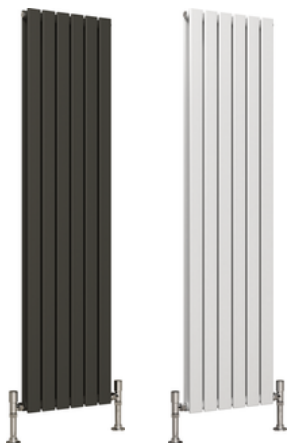

1600mm (h) x 490mm (w)
7 Sections

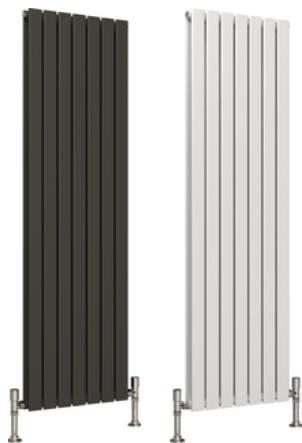

1600mm (h) x 560mm (w)
8 Sections

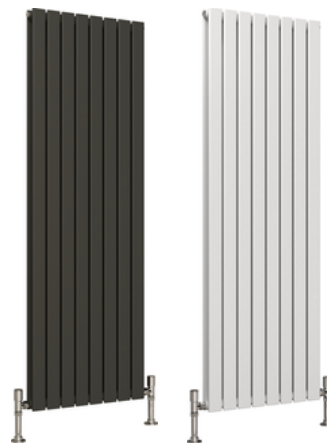

1800mm (h) x 350mm (w)
5 Sections

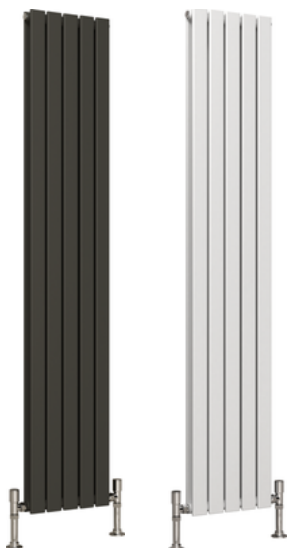

1800mm (h) x 420mm (w)
6 Sections

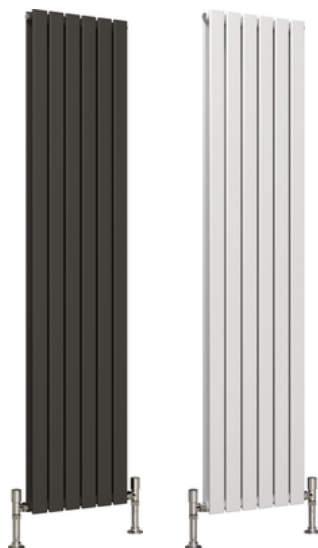

1800mm (h) x 490mm (w)
7 Sections

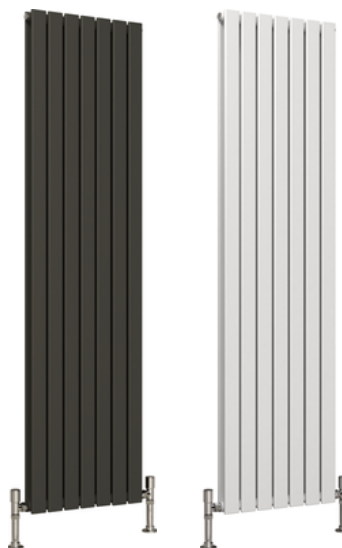

1800mm (h) x 560mm (w)
8 Sections

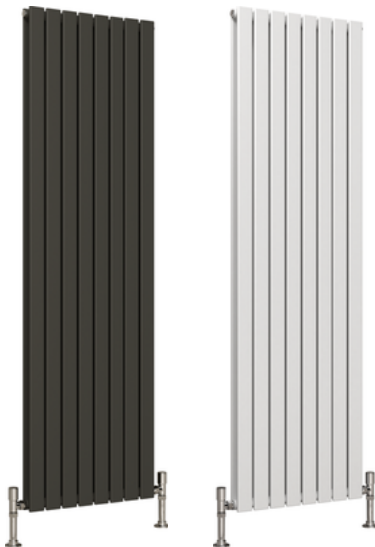

1800mm (h) x 630mm (w)
9 Sections

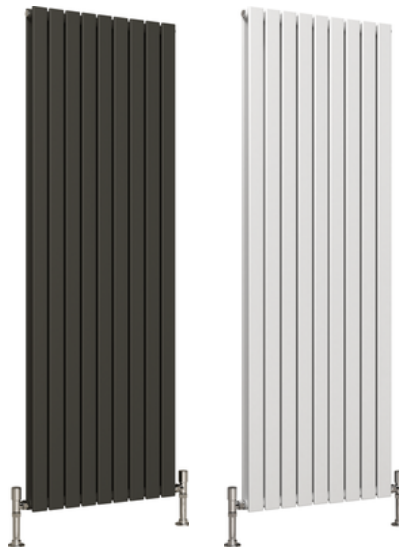

Scan QR code to view
full digital brochure

See page 34 for compatible valves

HARLEY Vertical Double



White

Anthracite

HARLEY Vertical Double

Overall Height mm	Dimension Width mm	Pipe Centres mm	Wall to Pipe Centres mm	Wall Distance mm	Number of Tubes	Heat Outputs Delta T 60 C	
						BTU	Watts
1600	420	420	63	94	12	4719	1384
1600	490	490	63	94	14	5505	1614
1600	560	560	63	94	16	6292	1845
1800	350	350	63	94	10	4445	1304
1800	420	420	63	94	12	5335	1565
1800	490	490	63	94	14	6223	1825
1800	560	560	63	94	16	7113	2086
1800	630	630	63	94	18	8001	2346

For pipe center measurement including valves add 90mm accordingly

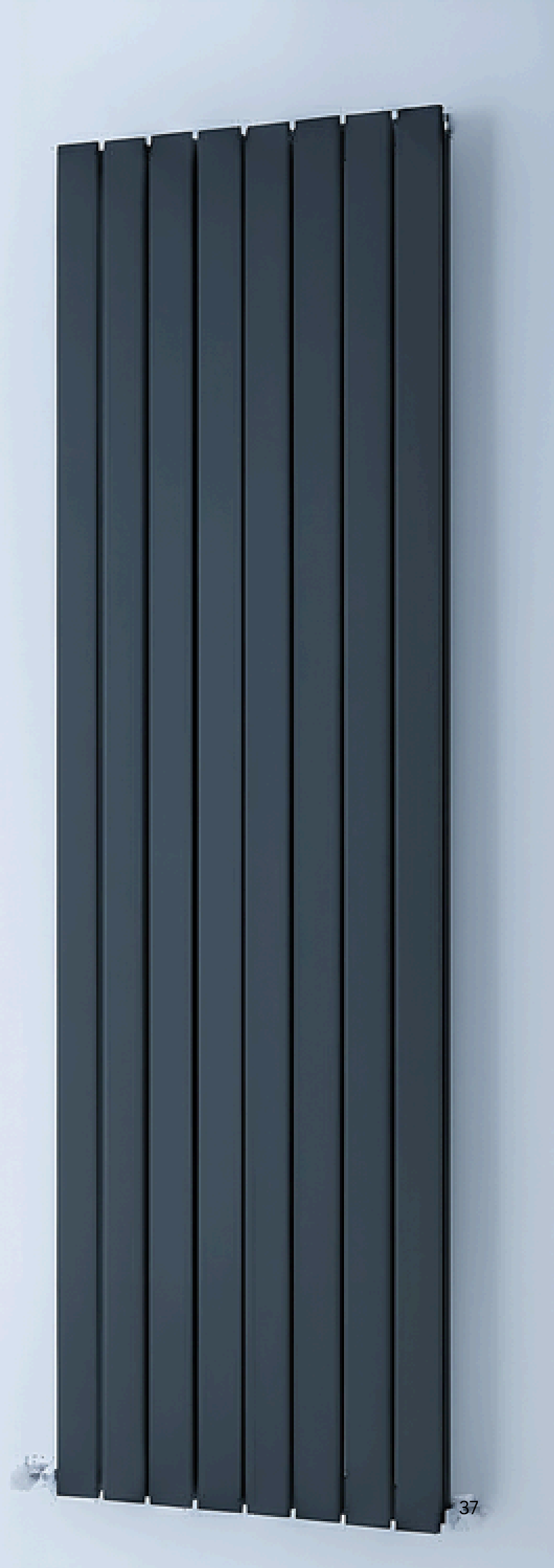

ELIPS

Horizontal Single

white

anthracite



5 YEAR GUARANTEE



QUALITY STEEL CONSTRUCTION



600mm (h) x 360mm (w)

6 Tubes



600mm (h) x 540mm (w)

9 Tubes



600mm (h) x 780mm (w)

13 Tubes



600mm (h) x 960mm (w)

16 Tubes

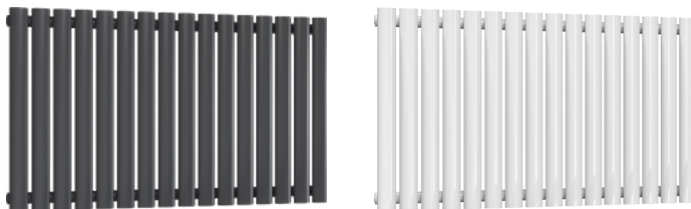

600mm (h) x 1140mm (w)

19 Tubes

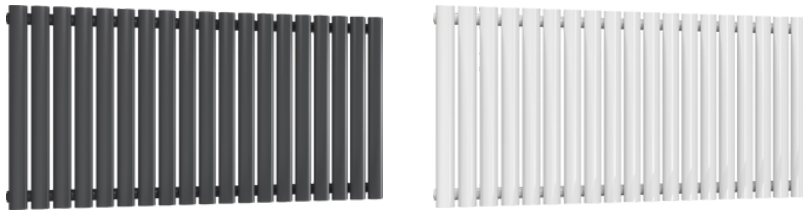

600mm (h) x 1440mm (w)

24 Tubes



Scan QR code to view
full digital brochure

See page 34 for compatible valves

ELIPS Horizontal Single



- White
- Anthracite

ELIPS Horizontal Single

Overall Height mm	Dimension Width mm	Pipe Centres mm	Wall to Pipe Centres mm	Wall Distance mm	Number of Tubes	Heat Outputs Delta T 60 C	
						BTU	Watts
600	360	360	50	92	6	1210	355
600	540	540	50	92	9	1814	532
600	780	780	50	92	13	2619	768
600	960	960	50	92	16	3223	945
600	1140	1140	50	92	19	3827	1122
600	1440	1440	50	92	24	4833	1417

For pipe center measurement including valves add 90mm accordingly



ELIPS

Horizontal Double

white

anthracite



5 YEAR GUARANTEE



QUALITY STEEL CONSTRUCTION



600mm (h) x 360mm (w)

12 Tubes



600mm (h) x 540mm (w)

18 Tubes



600mm (h) x 780mm (w)

26 Tubes



600mm (h) x 960mm (w)

32 Tubes



600mm (h) x 1140mm (w)

38 Tubes



600mm (h) x 1440mm (w)

48 Tubes



Scan QR code to view
full digital brochure

See page 34 for compatible valves

ELIPS Horizontal Double



ELIPS Horizontal Double

Overall Height mm	Dimension Width mm	Pipe Centres mm	Wall to Pipe Centres mm	Wall Distance mm	Number of Tubes	Heat Outputs Delta T 60 C	
						BTU	Watts
600	360	360	63	105	12	1842	540
600	540	540	63	105	18	2764	811
600	780	780	63	105	26	3991	1170
600	960	960	63	105	32	4911	1440
600	1140	1140	63	105	38	5833	1711
600	1440	1440	63	105	48	7368	2161

For pipe center measurement including valves add 90mm accordingly



ELIPS

Vertical Single

white

anthracite



5 YEAR GUARANTEE



QUALITY STEEL CONSTRUCTION

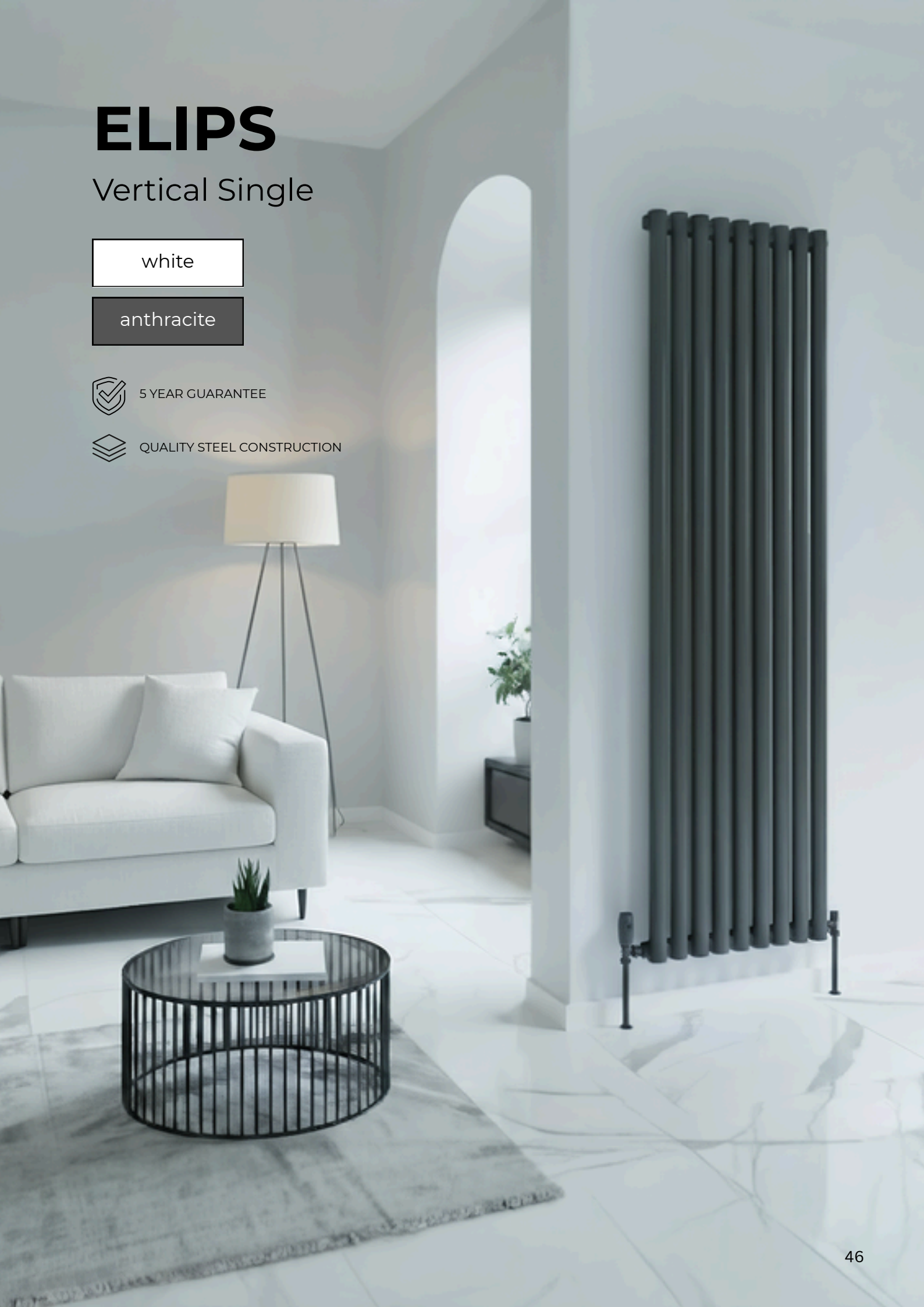

1600mm (h) x 420mm (w)
7 Tubes

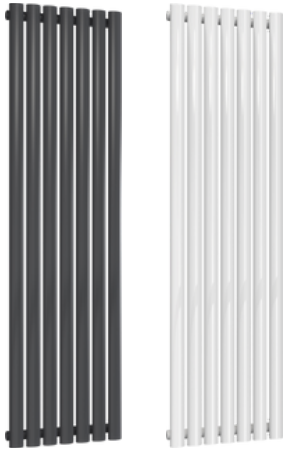

1600mm (h) x 540mm (w)
9 Tubes

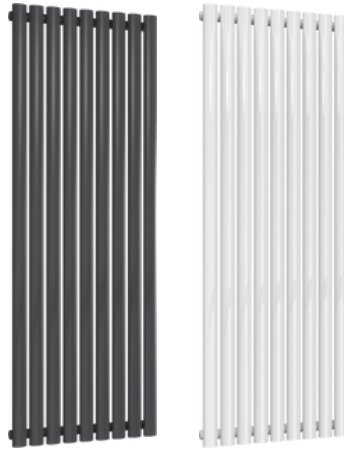

1800mm (h) x 300mm (w)
5 Tubes

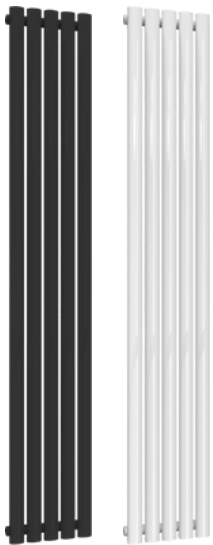

1800mm (h) x 420mm (w)
7 Tubes

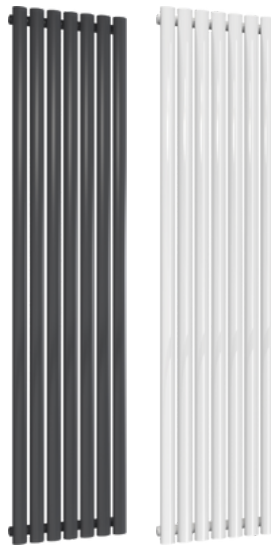

1800mm (h) x 540mm (w)
9 Tubes

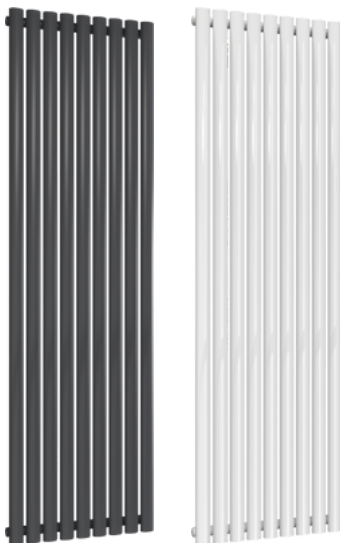

1800mm (h) x 600mm (w)
10 Tubes

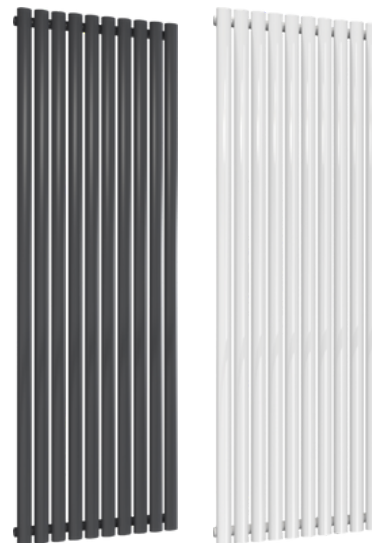

Scan QR code to view
full digital brochure

See page 34 for compatible valves

ELIPS Vertical Single



ELIPS Vertical Single

Overall Height mm	Dimension Width mm	Pipe Centres mm	Wall to Pipe Centres mm	Wall Distance mm	Number of Tubes	Heat Outputs Delta T 60 C	
						BTU	Watts
1600	420	420	50	92	7	3407	999
1600	540	540	50	92	9	4382	1285
1800	300	300	50	92	5	2697	791
1800	420	420	50	92	7	3777	1108
1800	540	540	50	92	9	4856	1424
1800	600	600	50	92	10	5396	1582

For pipe center measurement including valves add 90mm accordingly



ELIPS

Vertical Double

white

anthracite



5 YEAR GUARANTEE



QUALITY STEEL CONSTRUCTION

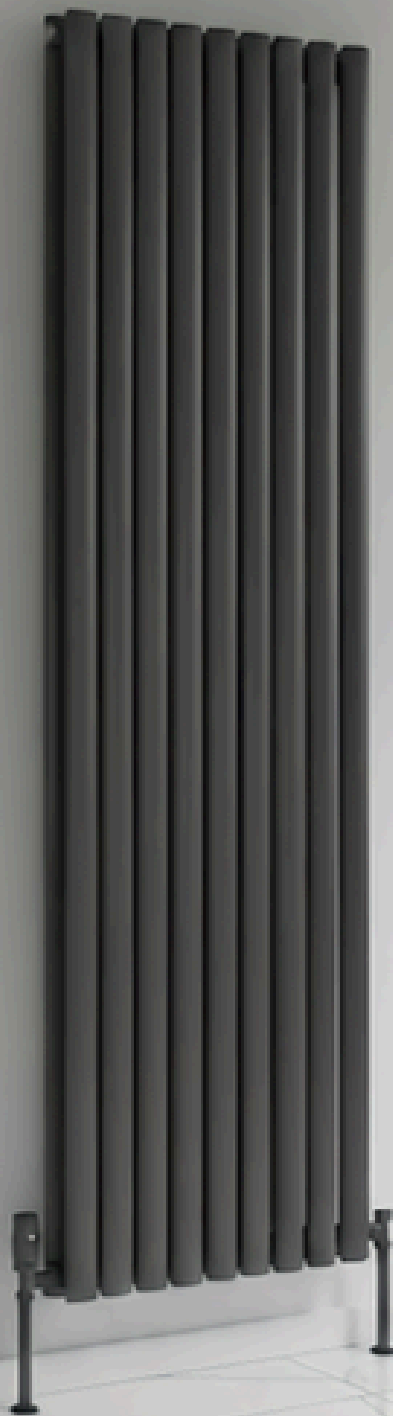

1600mm (h) x 420mm (w)

14 Tubes



1600mm (h) x 540mm (w)

18 Tubes

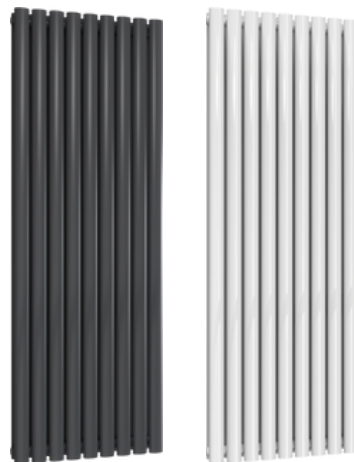

1800mm (h) x 300mm (w)

10 Tubes



1800mm (h) x 420mm (w)

14 Tubes



1800mm (h) x 540mm (w)

18 Tubes

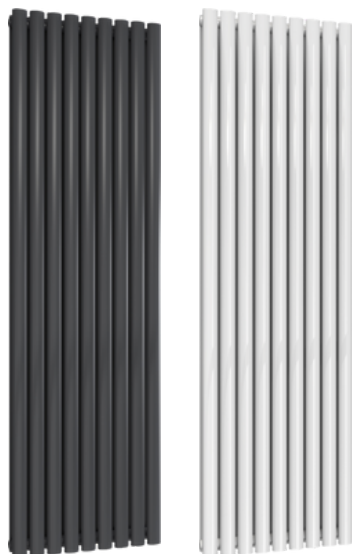

1800mm (h) x 600mm (w)

20 Tubes

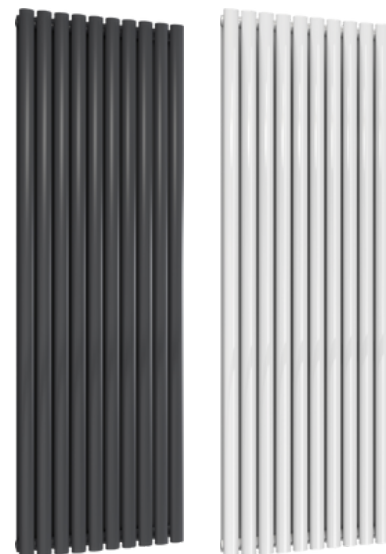

Scan QR code to view full digital brochure

See page 34 for compatible valves

ELIPS Vertical Double



White

Anthracite

ELIPS Vertical Double

Overall Height mm	Dimension Width mm	Pipe Centres mm	Wall to Pipe Centres mm	Wall Distance mm	Number of Tubes	Heat Outputs Delta T 60 C	
						BTU	Watts
1600	420	420	63	105	14	5004	1467
1600	540	540	63	105	18	6433	1887
1800	300	300	63	105	10	3985	1169
1800	420	420	63	105	14	5581	1637
1800	540	540	63	105	18	7174	2104
1800	600	600	63	105	20	7973	2338

For pipe center measurement including valves add 90mm accordingly



THERMOSTATIC ANGLED VALVES WITH LOCKSHIELD



Chrome



Anthracite



White

THERMOSTATIC CORNER VALVES WITH LOCKSHIELD



Chrome



Anthracite



White

THERMOSTATIC STRAIGHT VALVES WITH LOCKSHIELD



Chrome



Anthracite



White

MANUAL ANGLED VALVES



Chrome



Anthracite



White

MANUAL CORNER VALVES



Chrome



Anthracite



White

MANUAL CORNER VALVES



Chrome



Anthracite



White

SURREY ANGLED VALVES



CLASSICO FEET

Steel Construction
Aesthetical
Not load bearing
Height: 140mm

2 COLUMN



3 COLUMN



4 COLUMN



6 COLUMN



TECHNICAL DRAWINGS

ELIPS Horizontal Single

600mm (h) x 360mm (w)

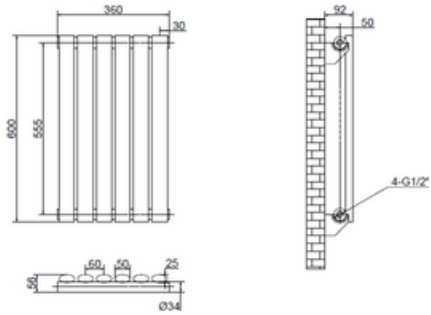

600mm (h) x 540mm (w)

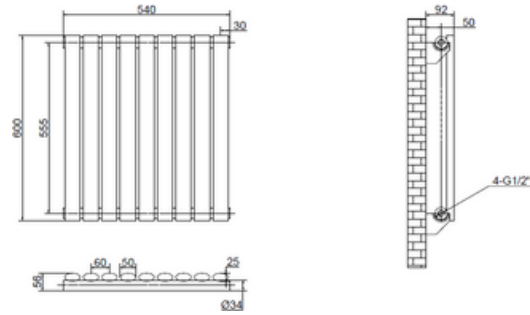

600mm (h) x 780mm (w)

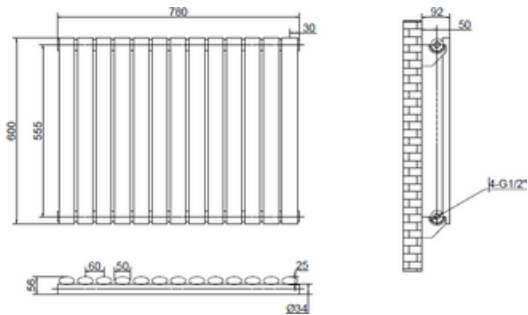

600mm (h) x 960mm (w)

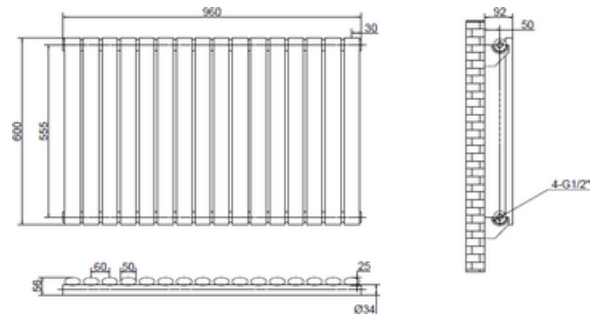

600mm (h) x 1140mm (w)

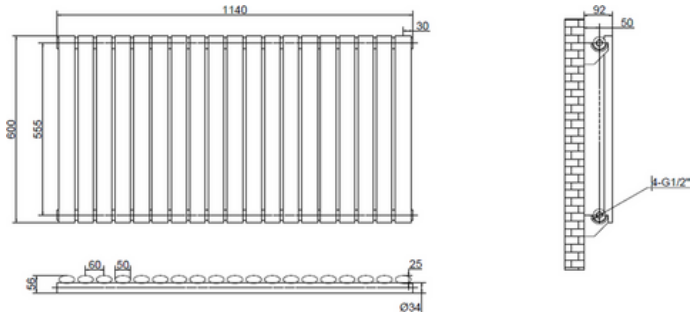

600mm (h) x 1440mm (w)

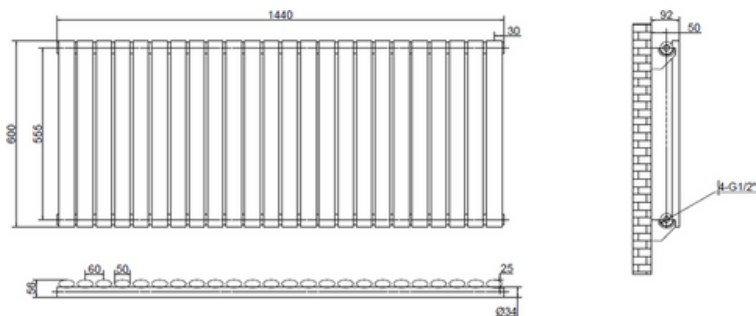

ELIPS Horizontal Double

600mm (h) x 360mm (w)

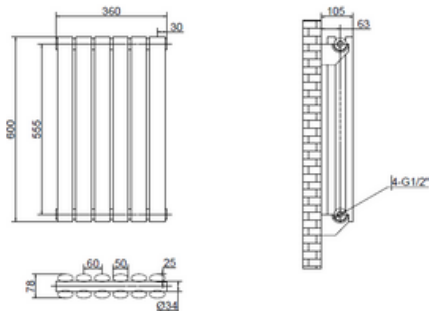

600mm (h) x 540mm (w)

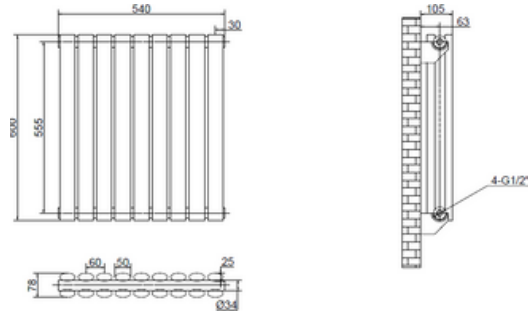

600mm (h) x 780mm (w)

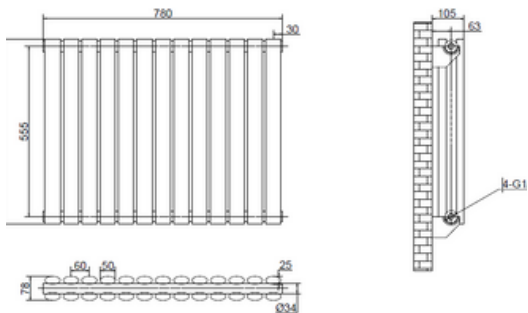

600mm (h) x 960mm (w)

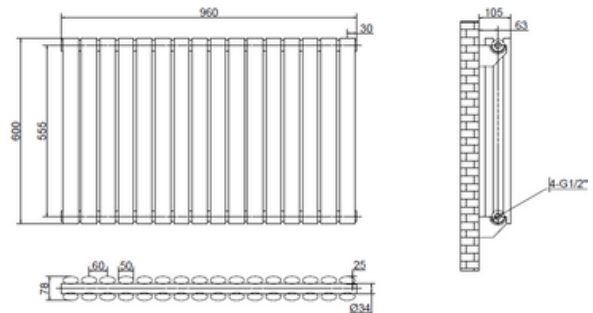

600mm (h) x 1140mm (w)

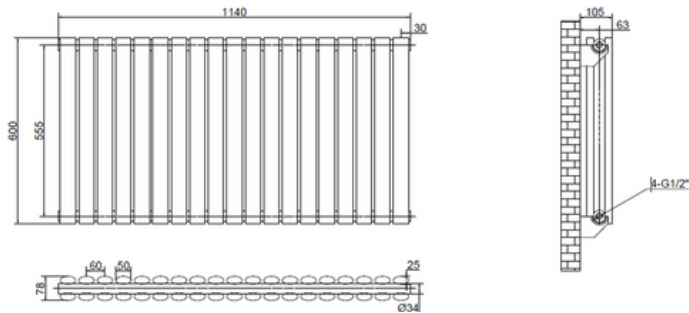

600mm (h) x 1440mm (w)

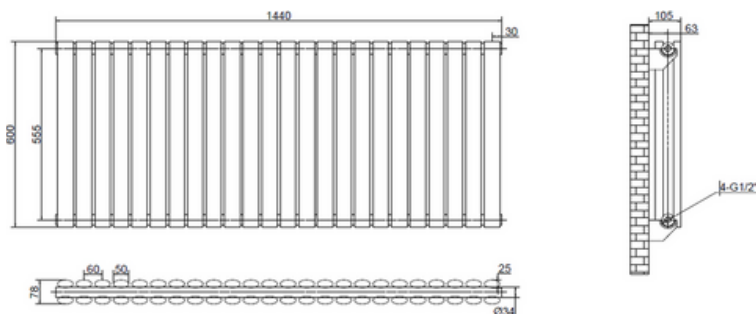

ELIPS Vertical Single

1600mm (h) x 420mm (w)

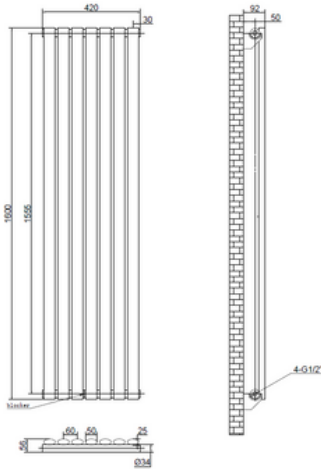

1600mm (h) x 540mm (w)

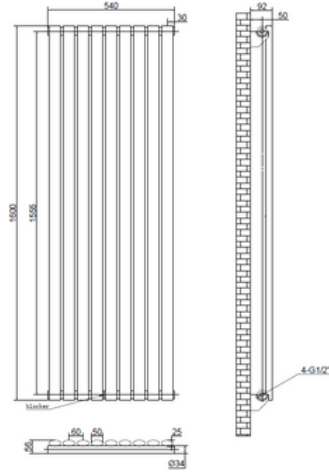

1800mm (h) x 300mm (w)

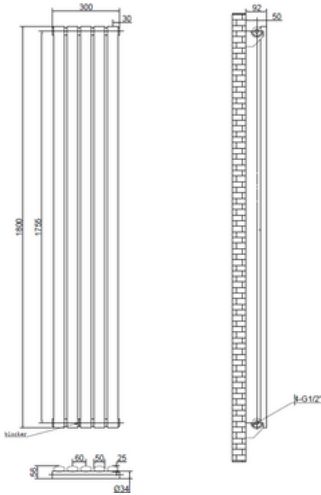

1800mm (h) x 420mm (w)

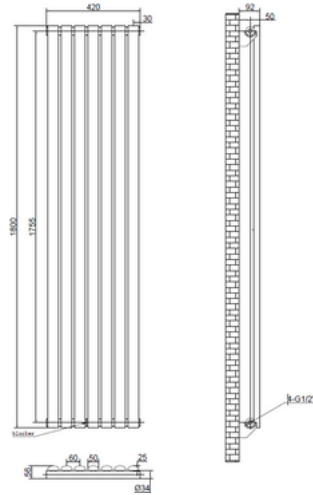

1800mm (h) x 540mm (w)

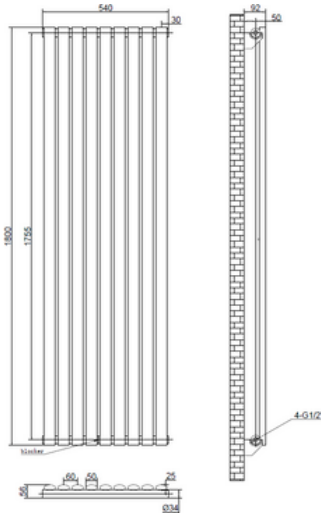

1800mm (h) x 600mm (w)

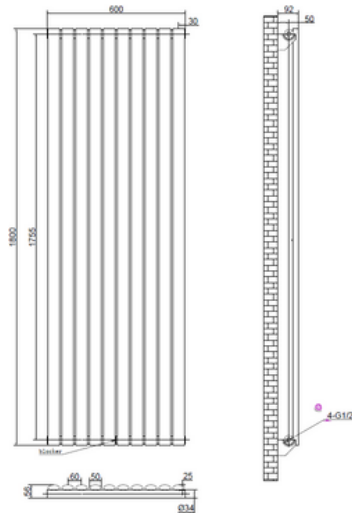

ELIPS Vertical Double

1600mm (h) x 420mm (w)

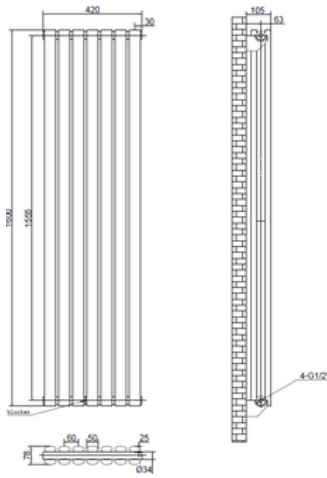

1600mm (h) x 540mm (w)

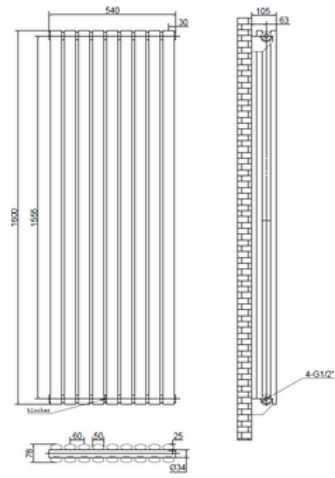

1800mm (h) x 300mm (w)

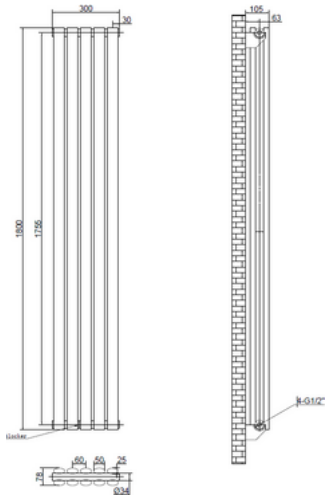

1800mm (h) x 420mm (w)

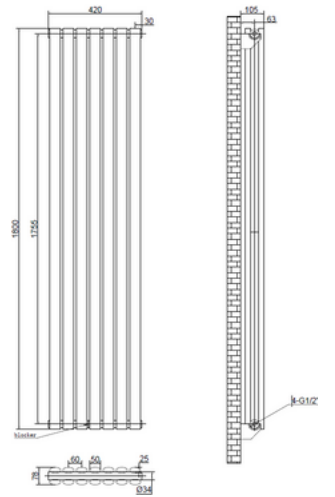

1800mm (h) x 540mm (w)

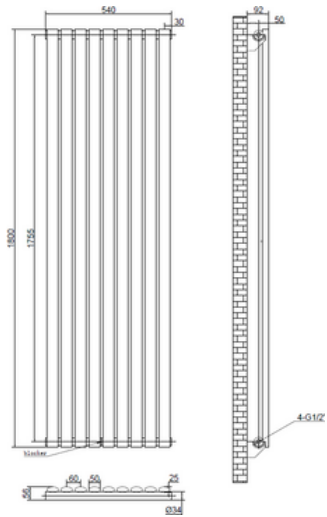

1800mm (h) x 600mm (w)

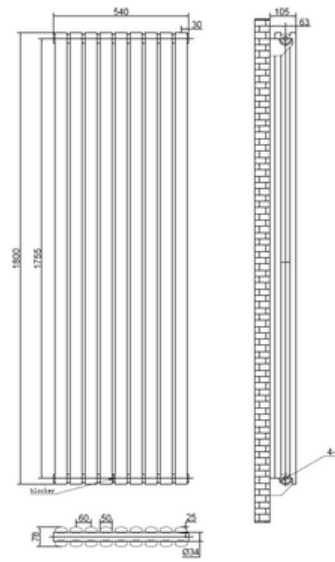

HARLEY Horizontal Single

600mm (h) x 420mm (w)

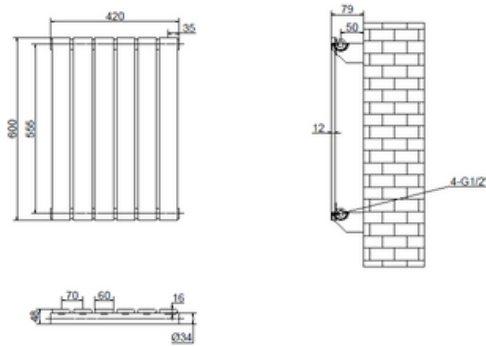

600mm (h) x 630mm (w)

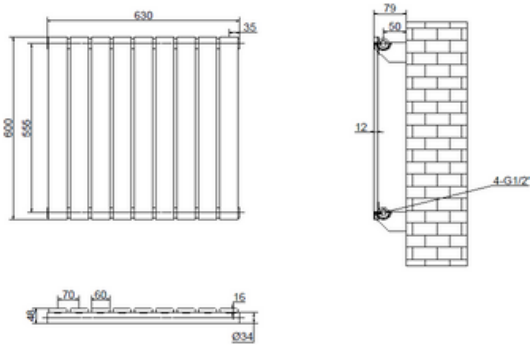

600mm (h) x 770mm (w)

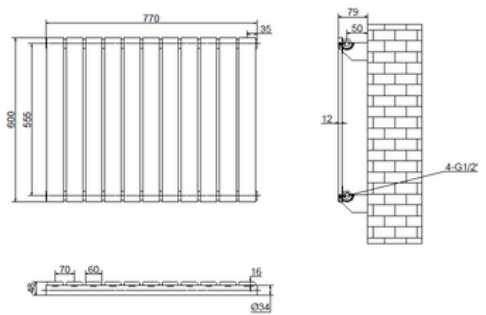

600mm (h) x 980mm (w)

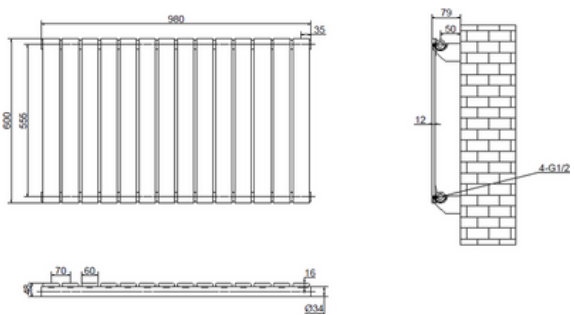

600mm (h) x 1190mm (w)

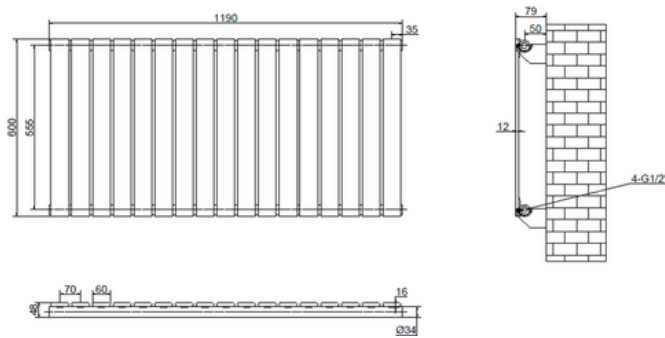

600mm (h) x 1470mm (w)

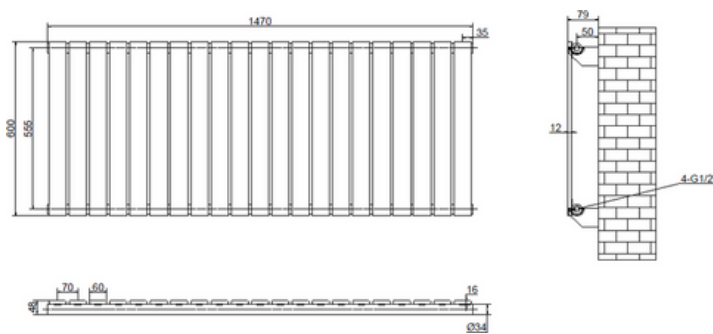

HARLEY Horizontal Double

600mm (h) x 420mm (w)

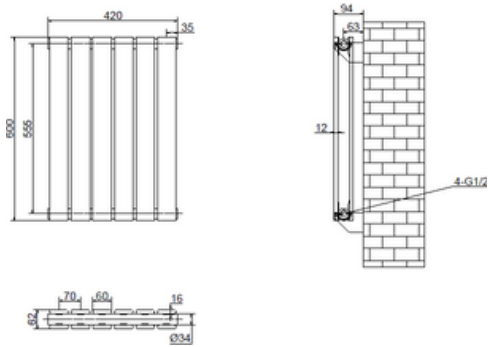

600mm (h) x 630mm (w)

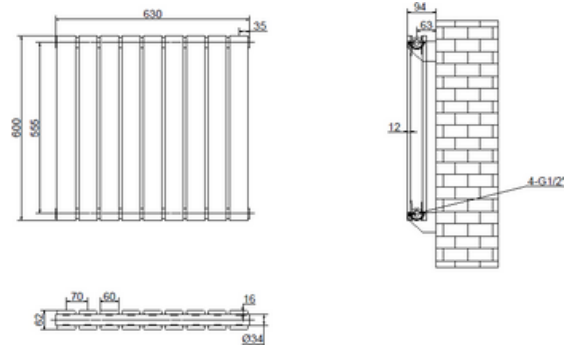

600mm (h) x 770mm (w)

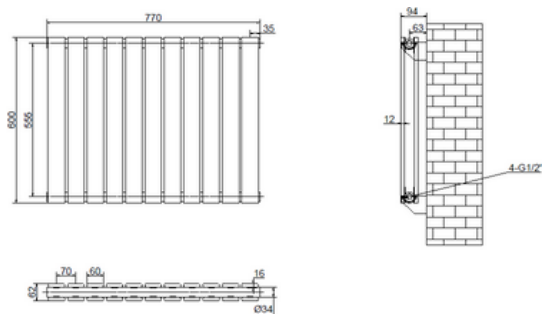

600mm (h) x 980mm (w)

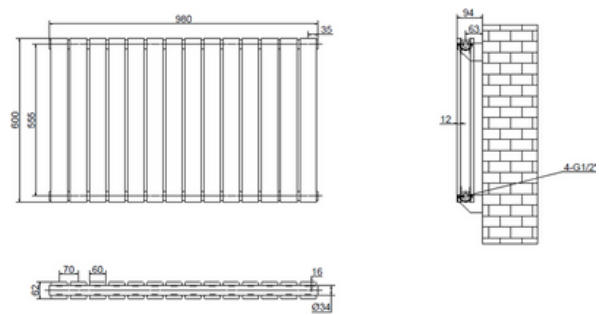

600mm (h) x 1190mm (w)

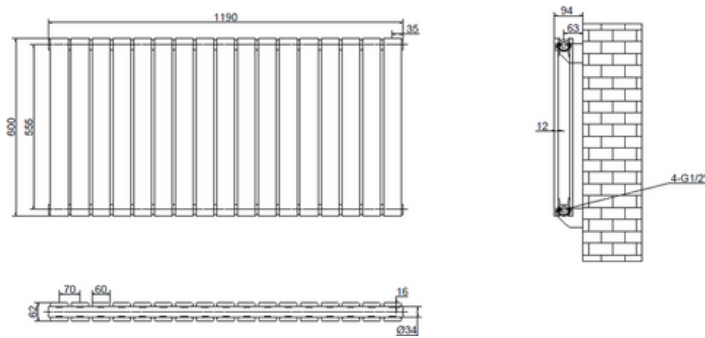

600mm (h) x 1470mm (w)

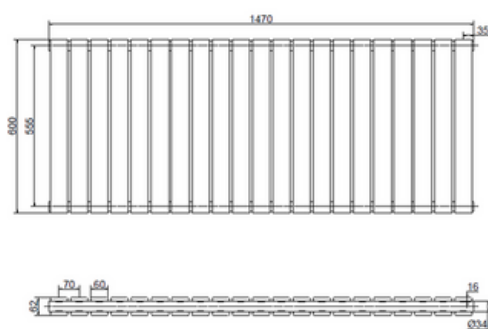

HARLEY Vertical Single

1600mm (h) x 420mm (w)

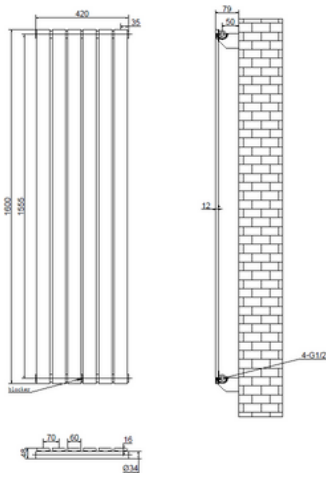

1600mm (h) x 490mm (w)

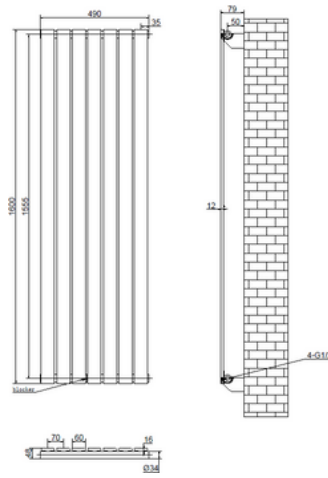

1600mm (h) x 560mm (w)

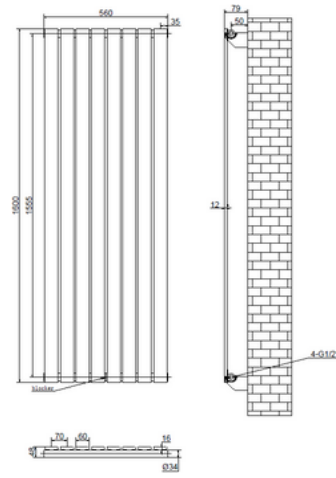

1800mm (h) x 350mm (w)

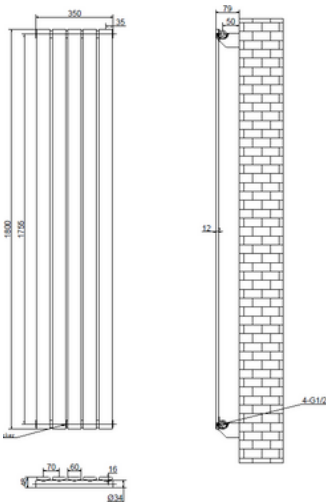

1800mm (h) x 420mm (w)

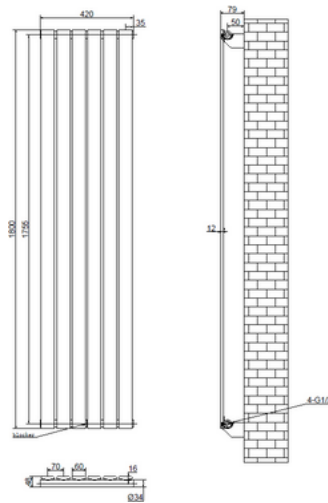

1800mm (h) x 490mm (w)

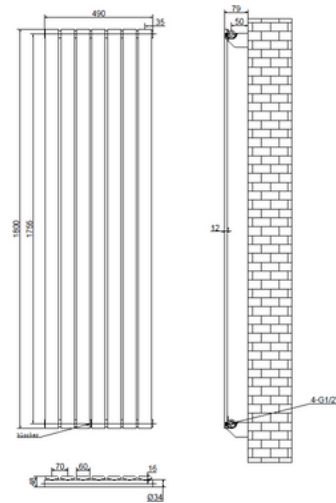

1800mm (h) x 560mm (w)

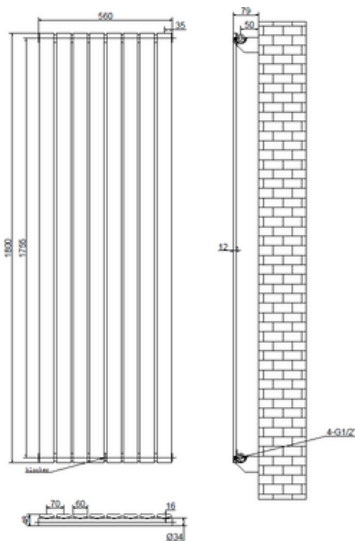

1800mm (h) x 630mm (w)

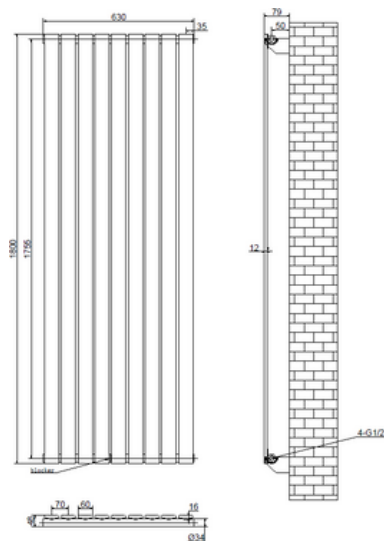

HARLEY Vertical Double

1600mm (h) x 420mm (w)

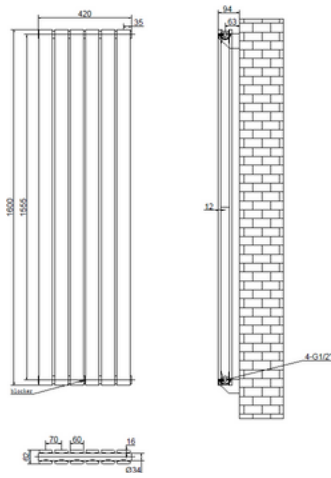

1600mm (h) x 490mm (w)

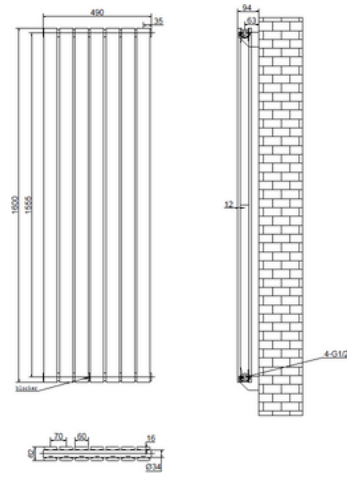

1600mm (h) x 560mm (w)

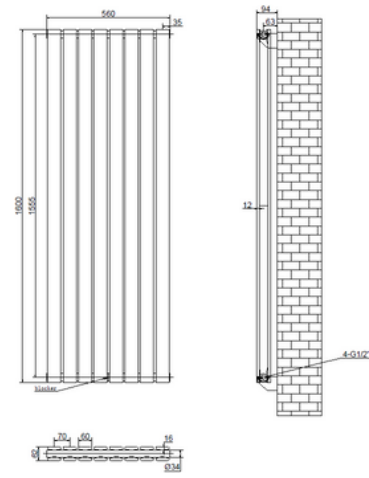

1800mm (h) x 350mm (w)

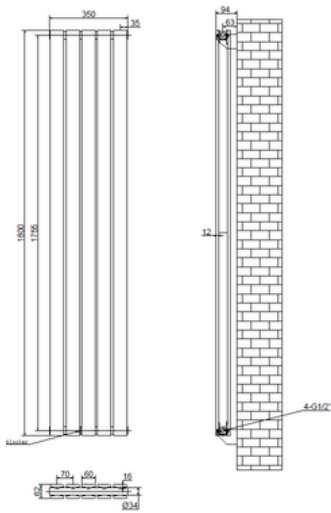

1800mm (h) x 420mm (w)

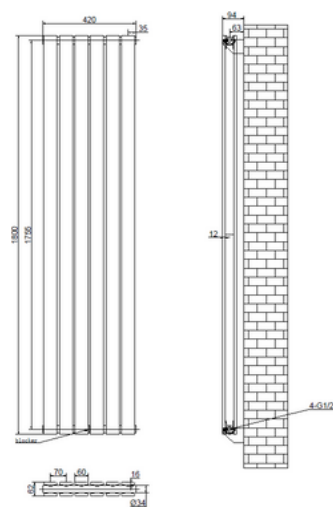

1800mm (h) x 490mm (w)

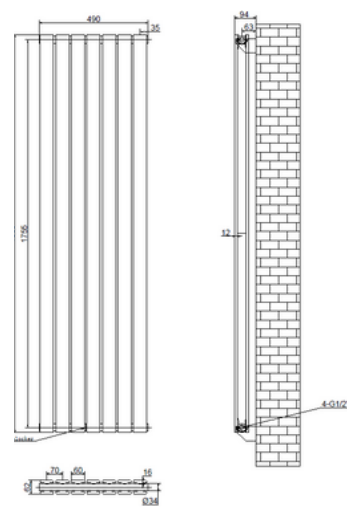

1800mm (h) x 560mm (w)

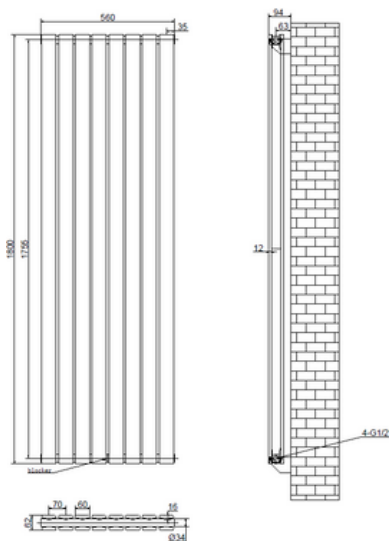

1800mm (h) x 630mm (w)

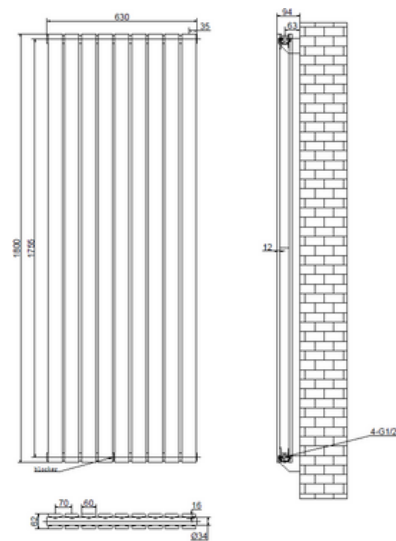

CLASSICO 2 Column Horizontal

500mm (h) x 425mm (w)

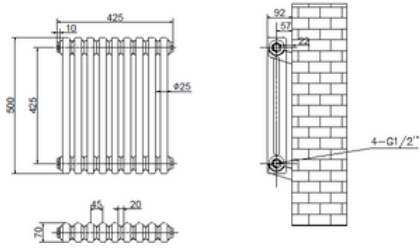

500mm (h) x 605mm (w)

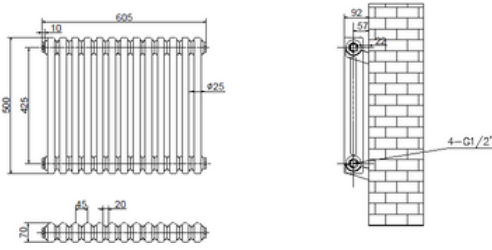

500mm (h) x 830mm (w)

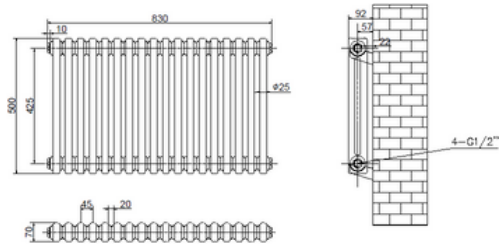

500mm (h) x 965mm (w)

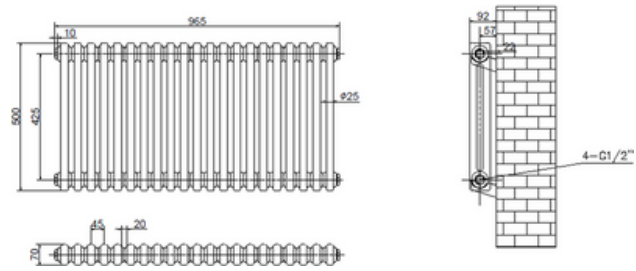

500mm (h) x 1190mm (w)

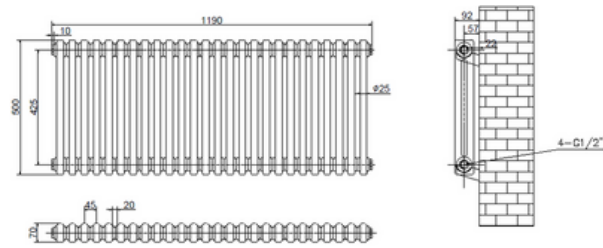

600mm (h) x 425mm (w)

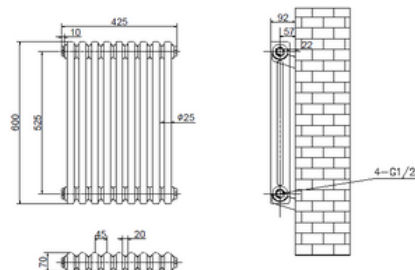

600mm (h) x 605mm (w)

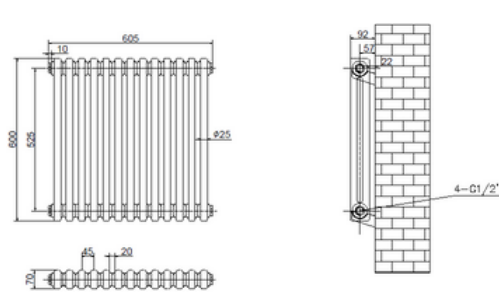

600mm (h) x 830mm (w)

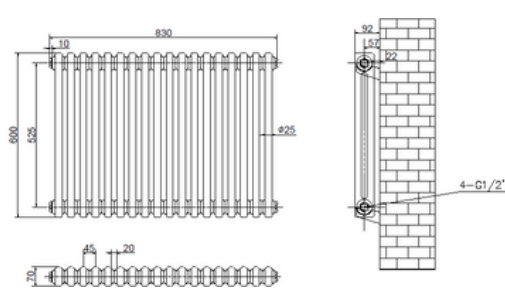

600mm (h) x 965mm (w)

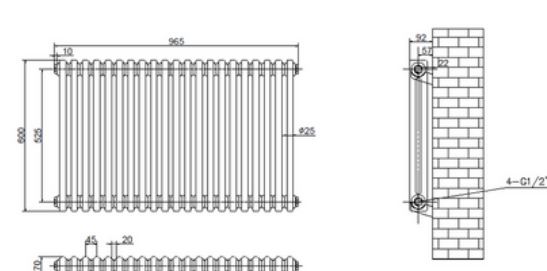

600mm (h) x 1190mm (w)

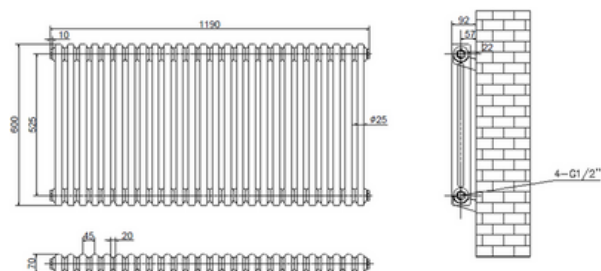

CLASSICO 3 Column Horizontal

300mm (h) x 830mm (w)

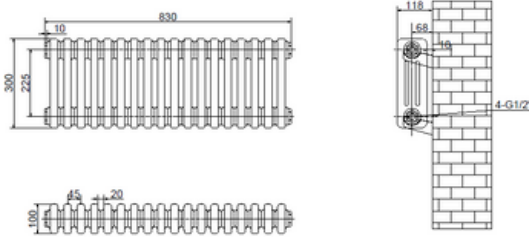

300mm (h) x 965mm (w)

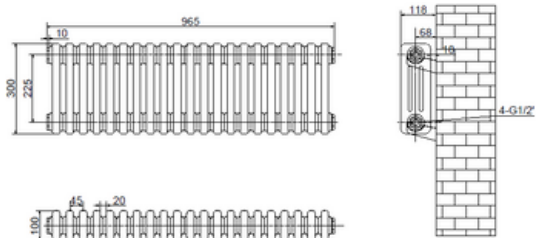

300mm (h) x 1190mm (w)

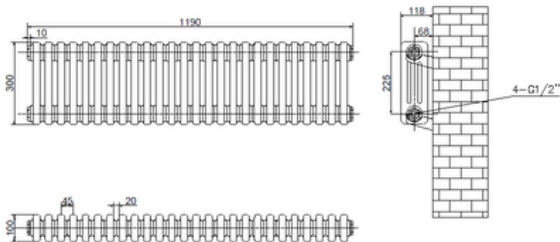

300mm (h) x 1370mm (w)

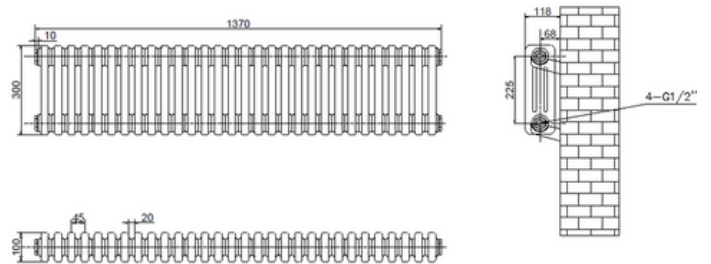

400mm (h) x 425mm (w)

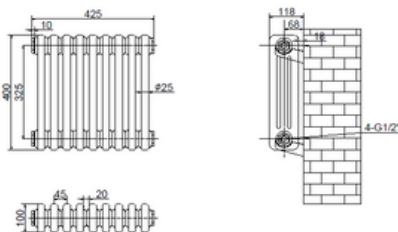

400mm (h) x 605mm (w)

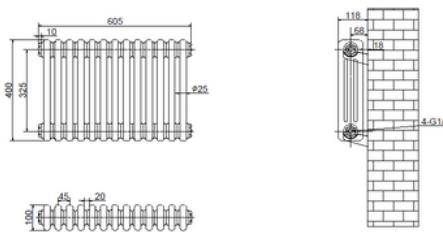

400mm (h) x 830mm (w)

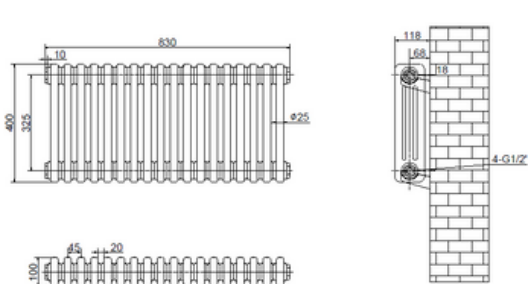

400mm (h) x 965mm (w)

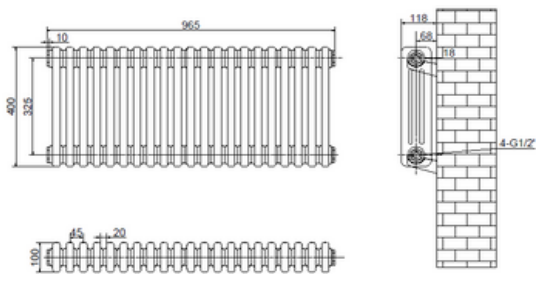

400mm (h) x 1190mm (w)

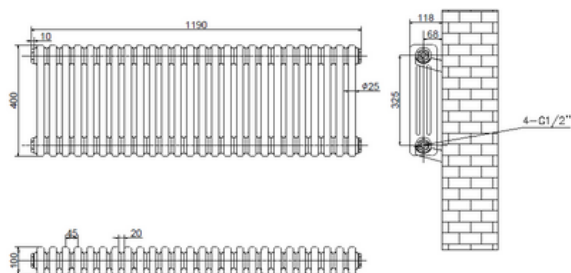

400mm (h) x 1370mm (w)

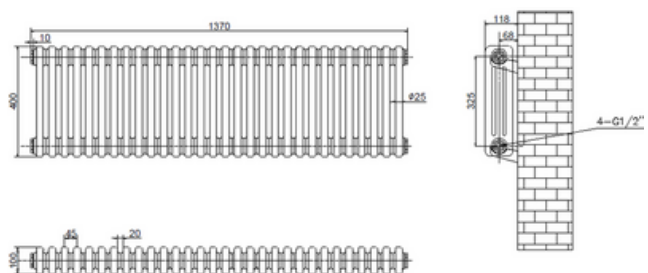

CLASSICO 3 Column Horizontal

500mm (h) x 425mm (w)

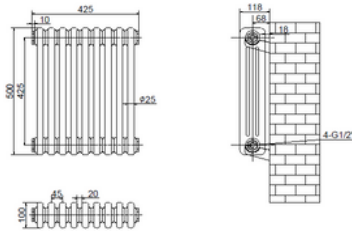

500mm (h) x 605mm (w)

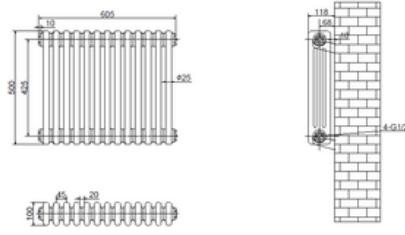

500mm (h) x 830mm (w)

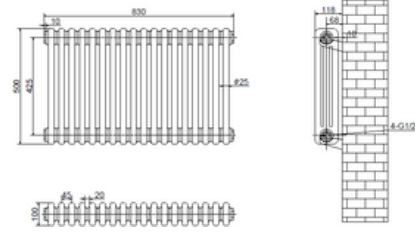

500mm (h) x 965mm (w)

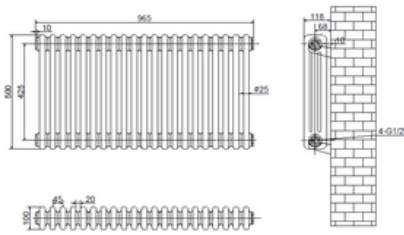

500mm (h) x 1190mm (w)

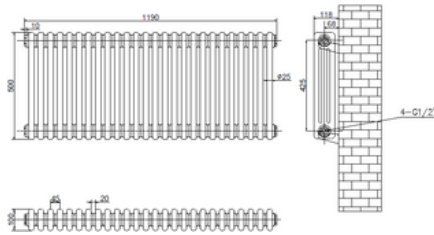

500mm (h) x 1370mm (w)

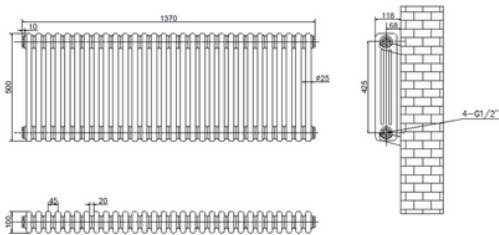

600mm (h) x 425mm (w)

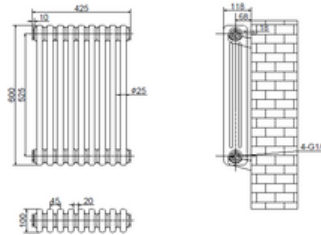

600mm (h) x 605mm (w)

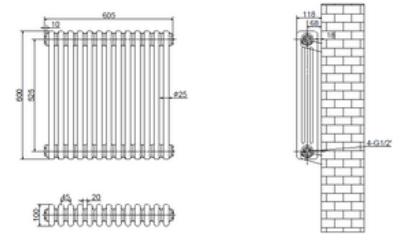

600mm (h) x 830mm (w)

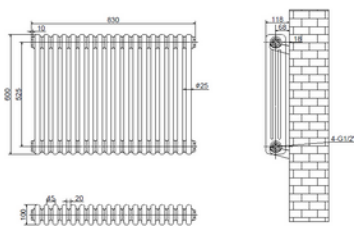

600mm (h) x 965mm (w)

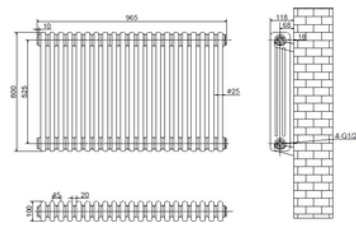

600mm (h) x 1190mm (w)

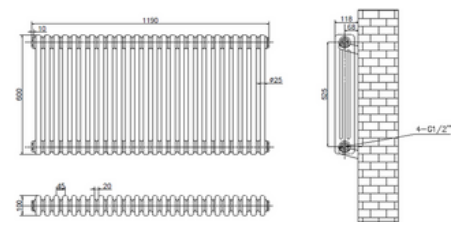

600mm (h) x 1370mm (w)

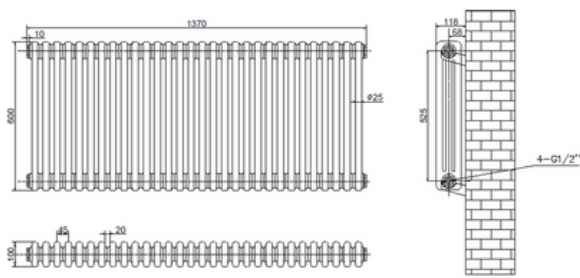

CLASSICO 3 Column Horizontal

750mm (h) x 425mm (w)

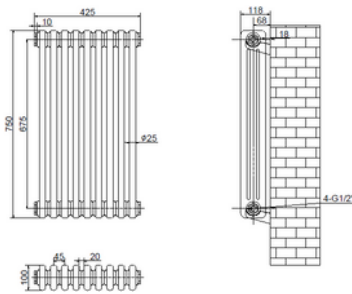

750mm (h) x 605mm (w)

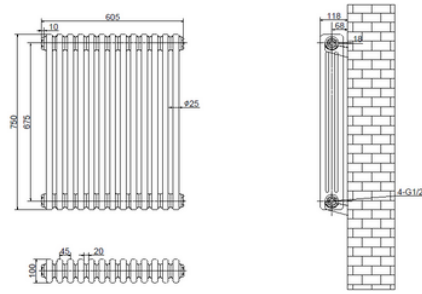

750mm (h) x 830mm (w)

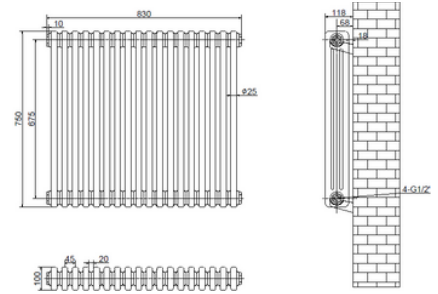

750mm (h) x 965mm (w)

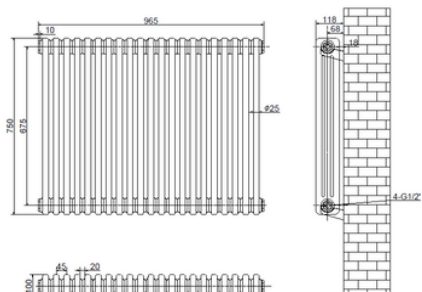

750mm (h) x 1190mm (w)

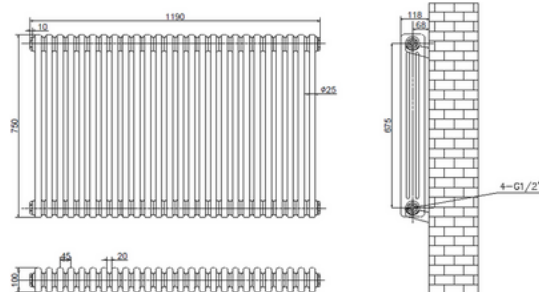

750mm (h) x 1370mm (w)

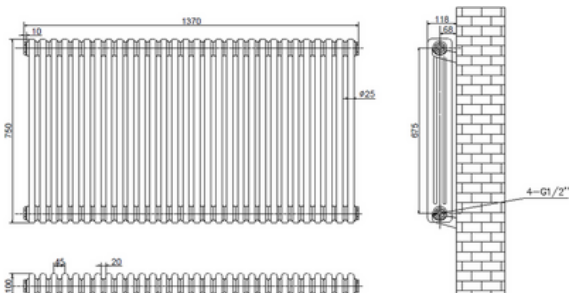

CLASSICO 4 Column Horizontal

300mm (h) x 830mm (w)

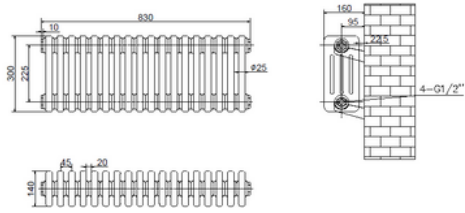

300mm (h) x 965mm (w)

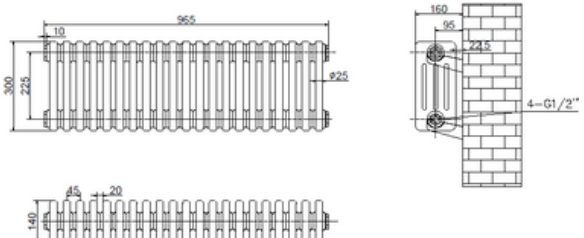

300mm (h) x 1190mm (w)

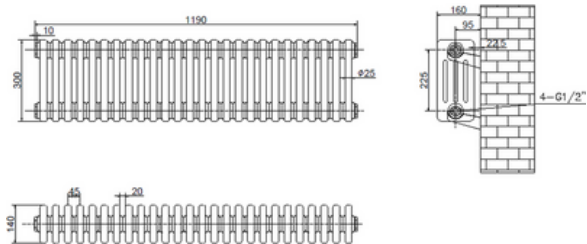

300mm (h) x 1370mm (w)

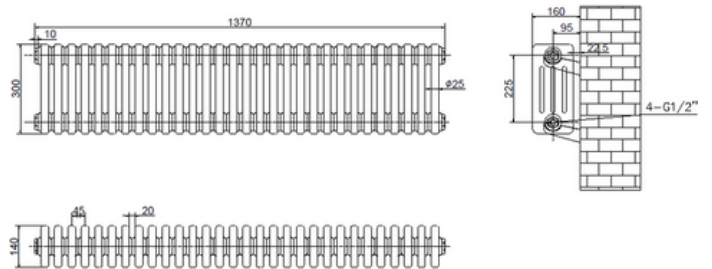

400mm (h) x 425mm (w)

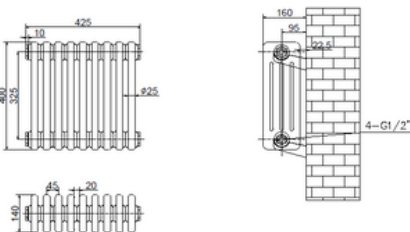

400mm (h) x 605mm (w)

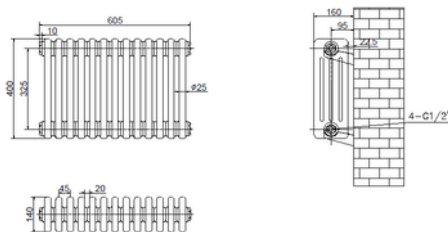

400mm (h) x 830mm (w)

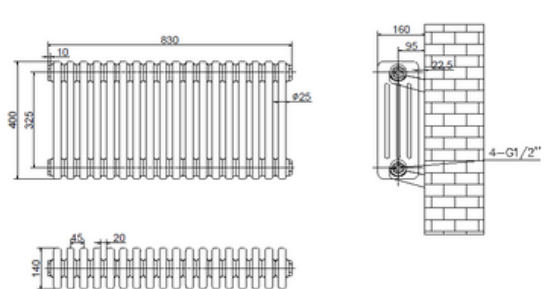

400mm (h) x 965mm (w)

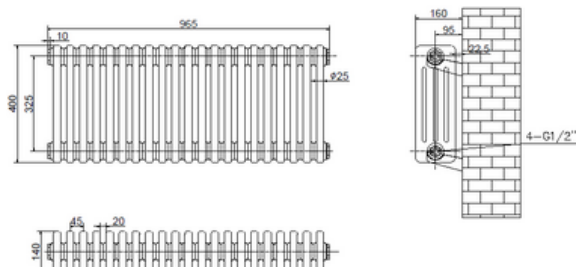

400mm (h) x 1190mm (w)

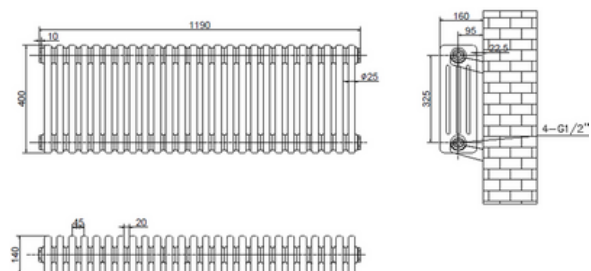

400mm (h) x 1370mm (w)

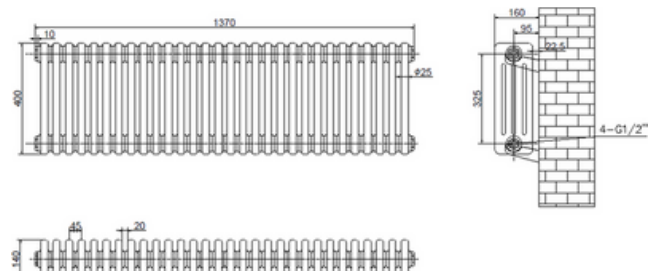

CLASSICO 4 Column Horizontal

500mm (h) x 425mm (w)

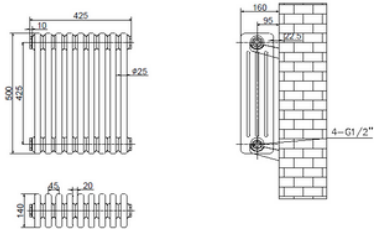

500mm (h) x 605mm (w)

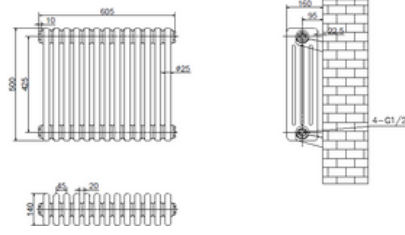

500mm (h) x 830mm (w)

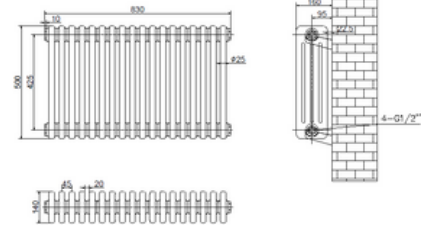

500mm (h) x 965mm (w)

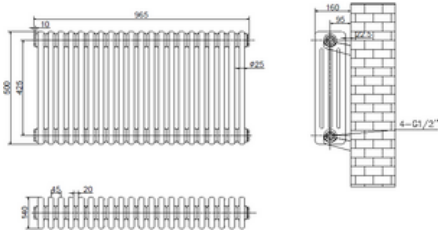

500mm (h) x 1190mm (w)

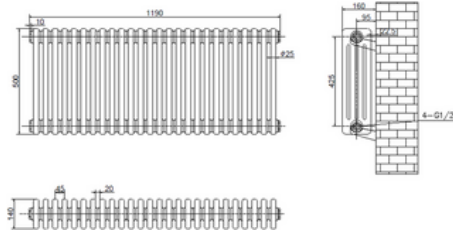

500mm (h) x 1370mm (w)

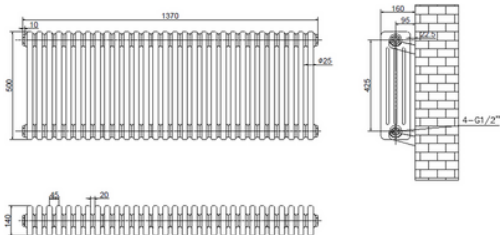

600mm (h) x 425mm (w)

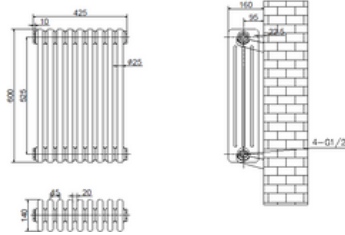

600mm (h) x 605mm (w)

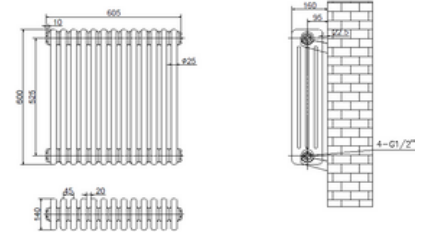

600mm (h) x 830mm (w)

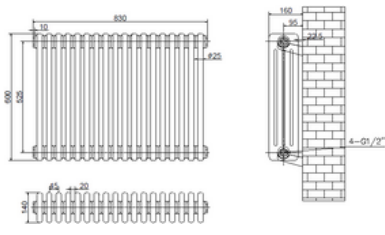

600mm (h) x 965mm (w)

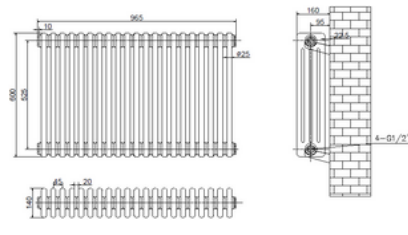

600mm (h) x 1190mm (w)

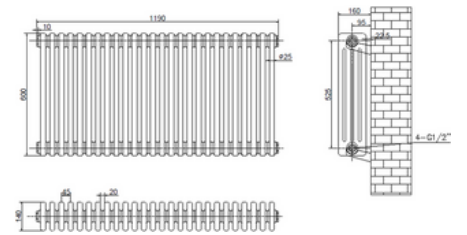

600mm (h) x 1370mm (w)

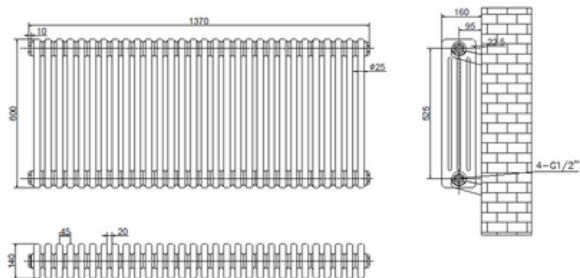

CLASSICO 4 Column Horizontal

750mm (h) x 425mm (w)

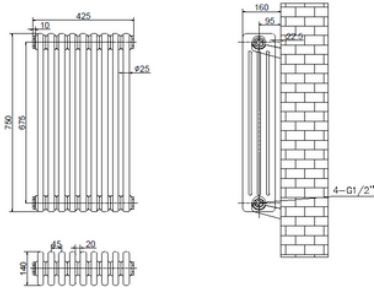

750mm (h) x 605mm (w)

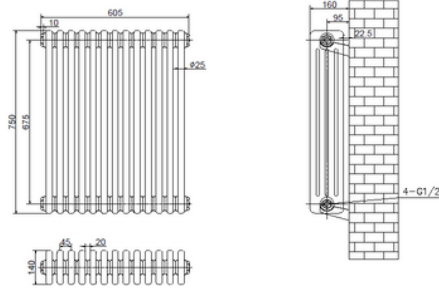

750mm (h) x 830mm (w)

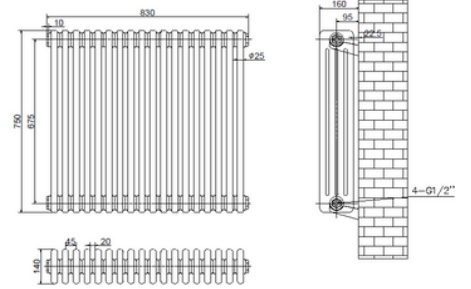

750mm (h) x 965mm (w)

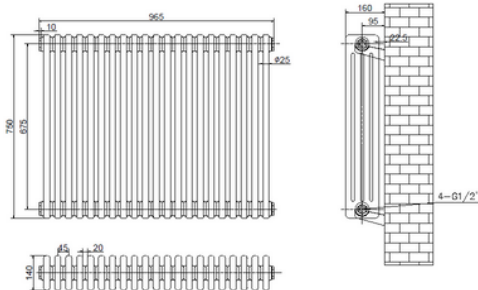

750mm (h) x 1190mm (w)

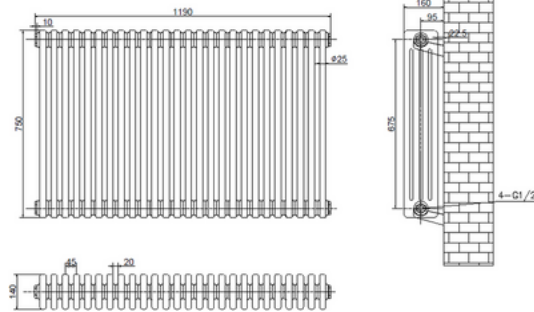

750mm (h) x 1370mm (w)

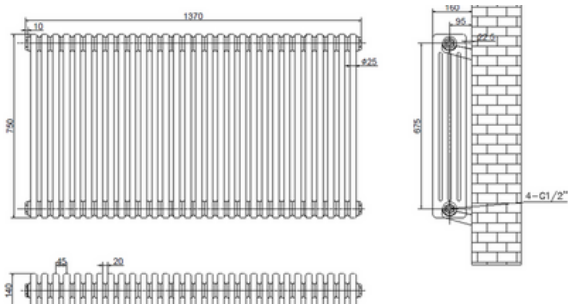

CLASSICO 6 Column Horizontal

300mm (h) x 830mm (w)

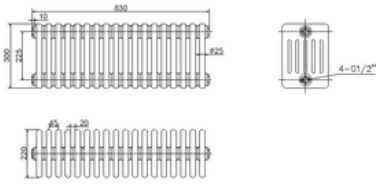

300mm (h) x 965mm (w)

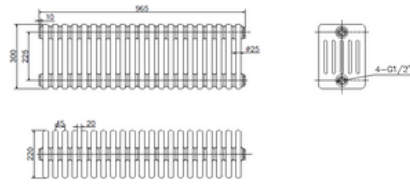

300mm (h) x 1190mm (w)

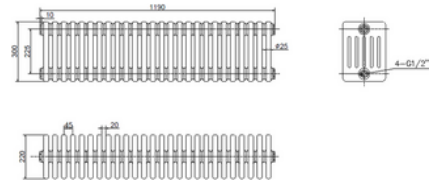

400mm (h) x 830mm (w)

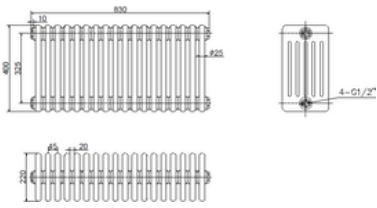

400mm (h) x 965mm (w)

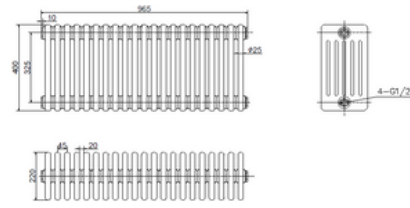

400mm (h) x 1190mm (w)

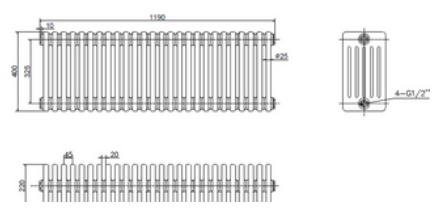

500mm (h) x 605mm (w)

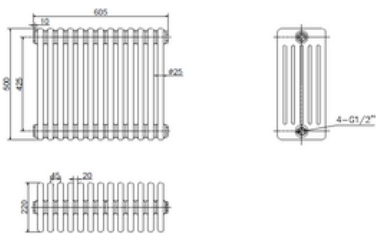

500mm (h) x 830mm (w)

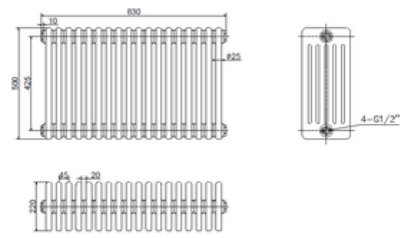

500mm (h) x 965mm (w)

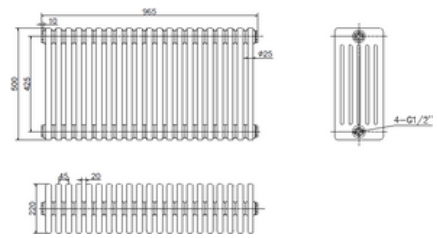

500mm (h) x 1190mm (w)

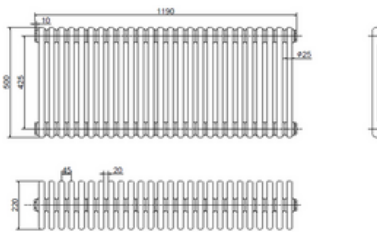

600mm (h) x 605mm (w)

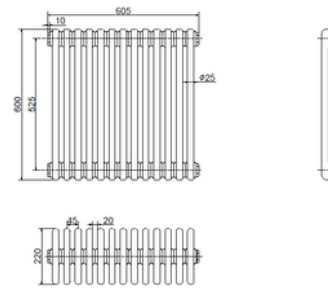

600mm (h) x 830mm (w)

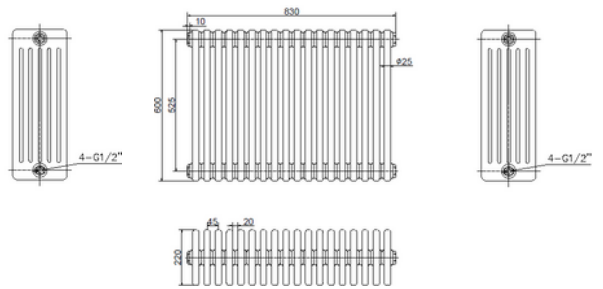

600mm (h) x 965mm (w)

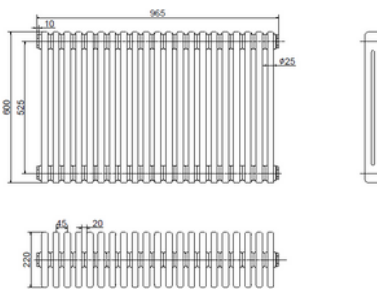

600mm (h) x 1190mm (w)

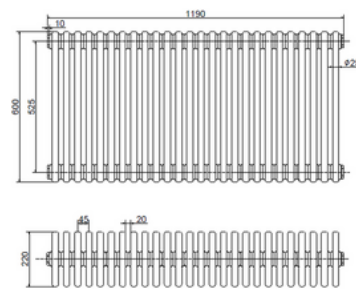

CLASSICO 2 Column Vertical

1500mm (h) x 425mm (w)

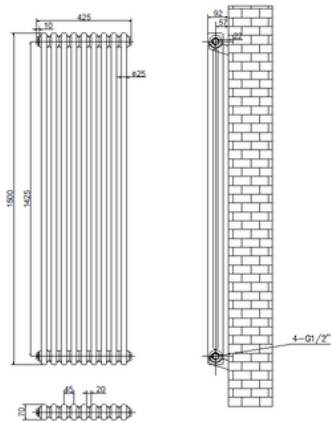

1500mm (h) x 515mm (w)

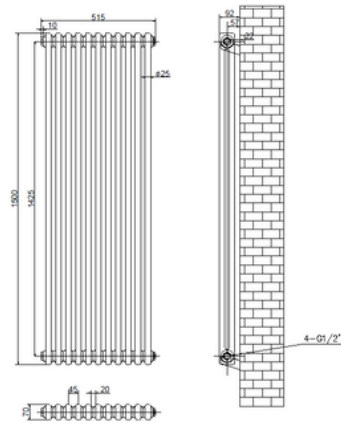

1800mm (h) x 245mm (w)

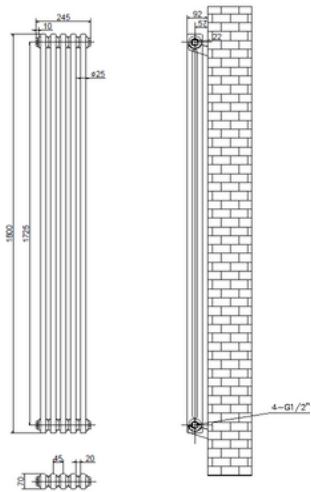

1800mm (h) x 335mm (w)

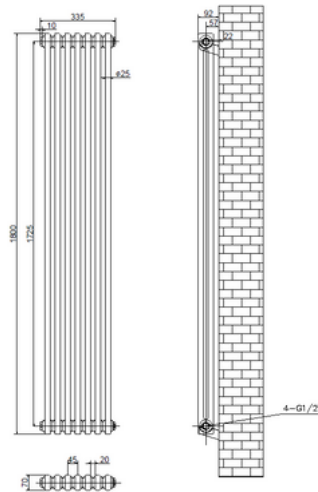

1800mm (h) x 425mm (w)

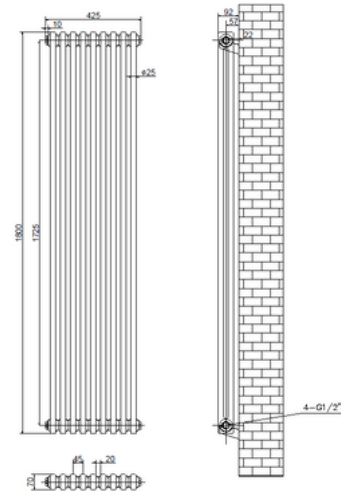

1800mm (h) x 515mm (w)

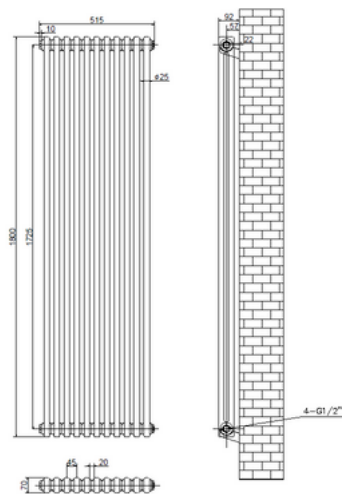

1800mm (h) x 560mm (w)

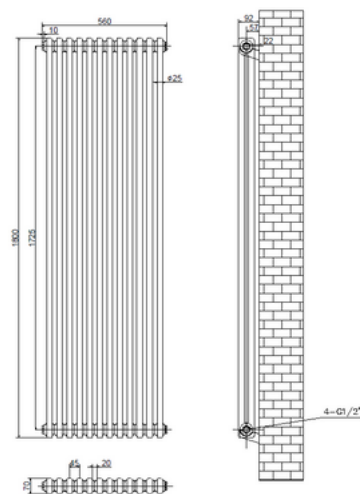

CLASSICO 3 Column Vertical

1500mm (h) x 425mm (w)

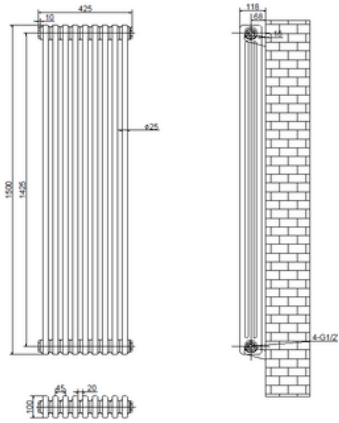

1500mm (h) x 515mm (w)

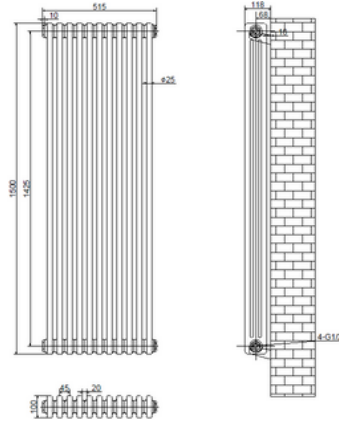

1800mm (h) x 245mm (w)

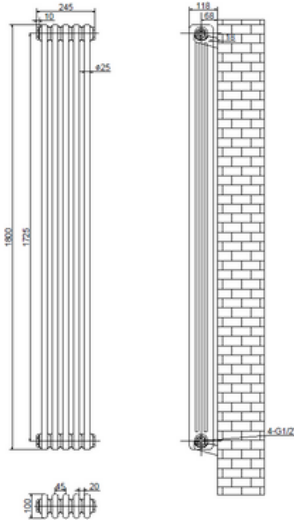

1800mm (h) x 335mm (w)

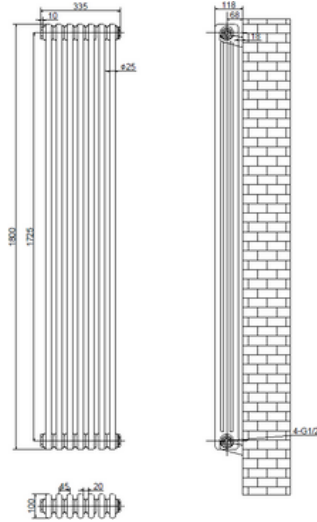

1800mm (h) x 425mm (w)

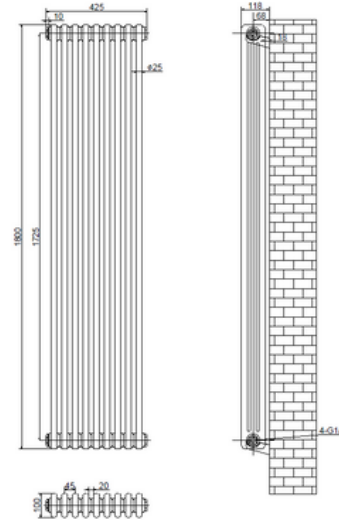

1800mm (h) x 515mm (w)

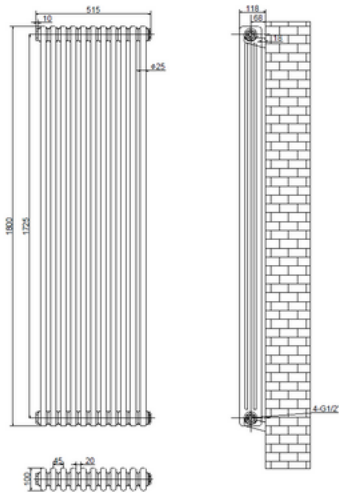

1800mm (h) x 560mm (w)

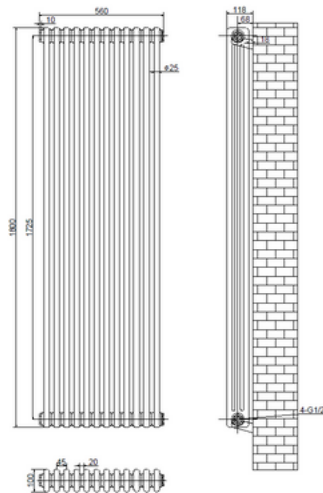

Why Choose V By Reina?



The ultimate all-round radiator: V By Reina radiators deliver the perfect balance of performance, design, and durability, making them the most popular and versatile choice across UK homes.



Outstanding heat retention: V By Reina radiators hold heat for longer, keeping your home warm and comfortable even after the heating is switched off — helping reduce energy consumption and costs.



Consistent, powerful heat output: Renowned for their steady and reliable warmth, our V By Reina mild steel radiators provide strong heat performance for every room size, from compact spaces to large open-plan living areas.



Premium build quality: Manufactured from high-grade mild steel, V By Reina radiators are built to last for years while maintaining their superior appearance and performance.



Perfect for all heating systems: Fully compatible with central heating this unique range performs exceptionally well with modern boilers and low-temperature systems, such as, air and ground source heat pumps.



Eco-friendly and sustainable: Mild Steel is one of the most widely recycled materials in the world, making it a sustainable choice “post manufacturing and lifecycle”, that supports environmentally conscious heating solutions.



Energy-efficient heating: V by Reina radiators are manufactured to deliver maximum heat output with full eco efficiency, our brand of radiators are ideal for those seeking comfort without compromise.



Exceptional value for money: Offering an unbeatable combination of affordability, strength, and heat performance, V By Reina radiators are a smart long-term investment for any property.



Trusted by professionals: With one of the broadest and most trusted ranges in the UK, our steel portfolio represents the best choice for homeowners, architects, and installers alike.



VALUE HEATING



<https://www.reinadesign.co.uk>

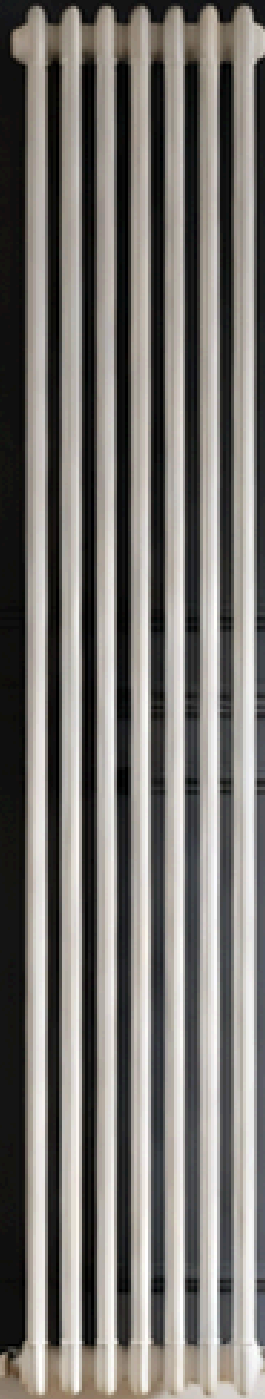

Atay Global Ltd, Unit 6 Weybridge Farm, Stambourne Road, Great Yeldham, Essex, CO9 4RB

Tel: 01787 238540

www.reinadesign.co.uk | info@atayglobal.com

In the interest of continuing design, development and product development, we reserve the right to change colours, designs and product specifications or method of manufacture. Such changes may be made without prior notice and without incurring any obligation. Indications of the colourways throughout this brochure are as accurate as photographic and print processes will allow. This brochure does not form part of a contract of sale. E&OE

REINA
DESIGNER RADIATOR